

*Complete, Easy To Read*  
**INSTALLATION AND OPERATING INSTRUCTIONS**

**LUX PSDH121 SERIES**  
**DIGITAL ELECTRONIC HEAT PUMP THERMOSTAT**

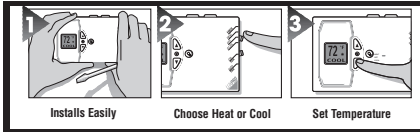

*Easy as*  
**1-2-3**

LUX PRODUCTS CORPORATION • Mt. Laurel, New Jersey 08054, USA 43368

**WARNING: Use Energizer® or DURACELL® Alkaline Batteries Only.**

Energizer® is a registered trademark of Eveready Battery Company, Inc.  
 DURACELL® is a registered trademark of The Gillette Company, Inc.



**IMPORTANT!**

Please read all instructions carefully before beginning installation and save for future reference. Before removing any wiring from your existing thermostat, its wires must be labeled with their terminal designations. Ignore the color of the wires since they may not comply with any standard.

Thank you for your confidence in our product. To obtain the best results from your investment, please read this manual and acquaint yourself with your purchase before installing your new thermostat. Then follow the installation procedures, one step at a time. This will save you time and minimize the chance of damaging the thermostat and the systems it controls. These instructions may contain information beyond that required for your particular installation. Please save for future reference.

**COMPATIBILITY**

LUX PSDH121 was designed for use with single stage heat pump systems with auxiliary and/or emergency heat. These systems are typical known as 2-stage heat one stage cool heat pump systems.

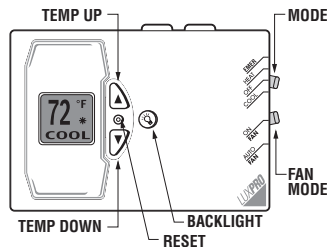

**FEATURES**

- Slim design may be vertically or horizontally mounted
- Large easy to read backlit display
- Fan switch for system or continuous fan operation
- Emergency Heat Switch
- Simple temperature Up or Down keys will display and adjust the Set Temperature.
- Temperature displays in F° or C°
- Temperature differential SWING settings of 0.25 and 0.5
- Selectable 2 or 5-Minute Minimum Run/Off time provides short cycle and compressor protection

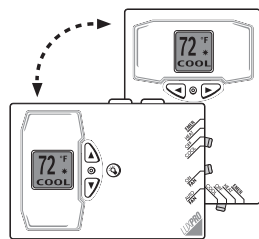

**OPERATING INSTRUCTIONS**

- In the winter, set the system switch to HEAT to control your system while heating.
- In the summer, set the switch to COOL to control your system while cooling.
- Press the TEMPERATURE UP or DOWN key in order to show the current SET TEMPERATURE.
- Press TEMPERATURE UP or DOWN keys again until your desired temperature is displayed. The display will show the current room temperature again after two seconds.
- Press the light bulb button to illuminate the display. Adjusting the temperature will keep the display lit until no button has been pressed for over ten seconds.
- In spring and fall or when windows are open, you can set the system switch to OFF.
- Setting the FAN switch to AUTO automatically runs your system's fan during heating and cooling.
- Setting the FAN switch to ON runs your system's fan continuously even without heating or cooling.
- Setting the Mode switch to EMER (emergency heat) runs your Emergency heating system rather than the heat pump.

**NOTE**

The FAN switch works only if your system provides a wire for a thermostat's "G" terminal.

**INSTALLATION**

Please read all instructions carefully before beginning installation.

**CAUTION**



\*\*\* Turn off electricity to the appliance before installing or servicing thermostat or any part of the system. Do not turn electricity back on until work is completed. \*\*\*

- Do not short (jumper) across electric terminals at control on furnace or air conditioner to test the system. This will damage the thermostat and void your warranty.
- All wiring must conform to local codes and ordinances.
- This thermostat is designed for use with 24 volt systems. The thermostat should be limited to a maximum of 1.5 amps; higher current may cause damage to the thermostat. If you are in doubt, call your HVAC contractor.
- Your thermostat is a precision instrument. Please handle it with care.

**TOOLS REQUIRED**

- #1 Phillips screwdriver (small)
- Drill with 3/16-in. (4.8mm) bit
- Wire stripper/cutter

**THERMOSTAT LOCATION**

On replacement installations, mount the new thermostat in place of the old one unless the conditions listed below suggest otherwise. On new installations, follow the guidelines listed below.

- Remember that your PSDH121 may be mounted vertically or horizontally when determining the optimal location.
- Locate the thermostat on an inside wall, about 5 ft. (1.5m) above the floor, and in a room that is used often.
- Do not install it where there are unusual heating conditions, such as: in direct sunlight; near a lamp, radio, television, radiator, register, or fireplace; near hot water pipes in a wall; near a stove on the other side of a wall.
- Do not locate in unusual cooling conditions, such as: on a wall separating an unheated room; or in a draft from a stairwell, door, or window.
- Do not locate in a damp area. This can lead to corrosion that will shorten thermostat life.
- Do not locate where air circulation is poor, such as: in a corner or an alcove; or behind an open door.
- Do not install the unit until all construction work and painting has been completed.

## CAUTION

Read instructions carefully before removing any wiring from existing thermostat. Wires must be labeled before they are removed. When removing wires from their terminals, ignore the color of the wires since they may not comply with any standard.

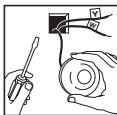

### REMOVING THE OLD THERMOSTAT

1. Switch electricity to the furnace and air conditioner OFF; then proceed with the following steps.
2. Remove cover from old thermostat. Most are snap-on types and simply pull off. Some have locking screws on the side. These must be loosened.

3. Note the letters printed near the terminals. Attach labels (enclosed) to each wire for identification. Label and remove wires one at a time. Make sure the wires do not fall back inside the wall.

4. Loosen all screws on the old thermostat and remove it from the wall.

### MOUNTING THE PSDH121 ON THE WALL

1. Decide whether the thermostat will be mounted vertically or horizontally.

## CAUTION

Be careful not to drop the unit or disturb electronic parts.



2. Strip insulation 3/8 in. (9.5mm) from wire ends and clean off any corrosion.
3. Fill wall opening with non-combustible insulation to prevent drafts from affecting the thermostat.

4. Cup the thermostat with one hand behind the thermostat's display. Separate the unit from its base plate using the tabs protruding from its body with the other hand.

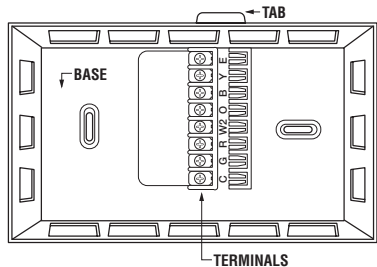
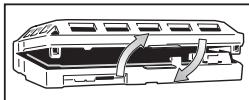

## NOTE

If you are mounting the base to a soft material like plasterboard or if you are using the old mounting holes, the screws may not hold. Drill a 3/16-in. (4.8mm) hole at each screw location, and insert the plastic anchors provided. Then mount the base as described below.

### ATTACHING WIRES



5. Route the wires through the large hole in the base plate by the terminal block. Hold the base against the wall, with the wires coming through. Position the base for best appearance (to hide any marks from an old thermostat). The terminal block should be either to the right of or below the routing hole. Attach the base to the wall with the two screws provided.

**PLEASE REVIEW THE WIRING DIAGRAMS IN THE NEXT COLUMN FOR PROPER TERMINAL CONNECTION**

## CAUTION

Do not allow wires to touch each other or parts on thermostat. Terminated wires must be trapped between black spacer and brass terminal. Securely tighten all eight electrical terminal screws.

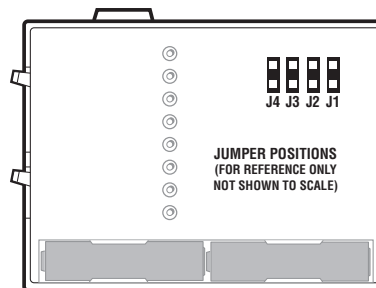

### INSTALLATION OPTIONS

There are four options which are set by a group of numbered jumpers on the rear of the units circuit board. They are:

**J1:** The minimum run time jumper J1 sets the minimum length of time that the thermostat must remain with Heat or Cool either on or off before it will automatically switch to the alternate On or Off state. This feature prevents short cycling, and provides compressor protection for cooling units. Choices are 2 or 5 minutes.

**J2:** The temperature format: jumper selects whether your thermostat displays temperatures in Celsius or Fahrenheit.

**J3:** This Jumper determines whether the display will be horizontally or vertically oriented.

**J4:** This Jumper controls the "swing" or temperature variation in the home. Using the smaller number results in more stable temperature, while the wider setting is provided as a more energy efficient alternative. Users of force hot water systems may find the 0.25 setting more comfortable.

The table at left is printed on the circuit board. To change a jumper position. The closed or shorted position is that which covers both a jumper's pins. To prevent its loss, a jumper may be placed over one pin only for the open positions. After settings have been changed, press the small-unmarked **RESET** button on the front of the thermostat for the changes to take effect.

	CLOSE	OPEN
<b>J1</b>	<b>5 min</b>	<b>2 min</b>
<b>J2</b>	<b>F</b>	<b>C</b>
<b>J3</b>	<b>Horizontal</b>	<b>Vertical</b>
<b>J4</b>	<b>Swing=0.5</b>	<b>Swing=0.25</b>

### INSTALL BATTERIES

For detailed instruction, see **BATTERIES/MAINTENANCE** to install batteries at this time.

- Turn the power back on to your heating and/or air conditioning system.
- Verify that the system and its fan are operating properly. When set to a high temperature, the heating system should provide warm air after a short time. Likewise, a cooling system should provide cool air after a short time. Usually sound from the furnace and air conditioning units can be heard while they are running. The rush of moving air should be heard within a short time after either has been started.
- The Installation is now complete.

## CALIBRATION

Your thermostat is carefully calibrated at the factory, and will measure temperature to within  $\pm 1^\circ$ . However, you can adjust the reading of your thermostat:

- Slide the **MODE** switch to **OFF**.
- Press and hold the Up and Down buttons until the display shows a single digit between  $+5F^\circ(+3C^\circ)$  and  $-5F^\circ(-3C^\circ)$ .
- Then the Up or Down buttons may be used to adjust the reading.
- The display will return to normal operation after 4 seconds without an adjustment.

# BATTERIES/MAINTENANCE

1. Remove fresh batteries from their carton.
2. Remove body of thermostat as described during installation.
3. Remove the used batteries if present.
4. Install two new Energizer® or DURACELL® "AA" size alkaline batteries in the battery compartment. Observe the polarity marking shown in the compartment.

**WARNING: Use Energizer® or DURACELL® Alkaline Batteries Only.**

5. Place the body back on the wall.
6. Using a small Phillips screwdriver press the RESET button which is between the Up/Down arrow button. Within 90 seconds the thermostat will begin to display the room temperature.

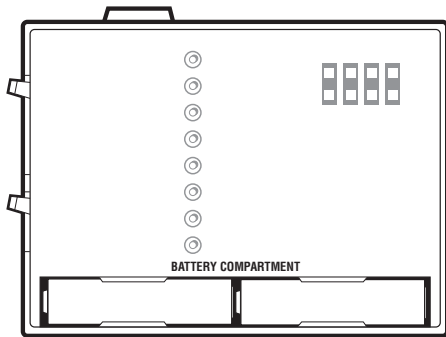

## NOTE

REPLACE BATTERIES WHEN LOBAT APPEARS IN THE DISPLAY OR AT LEAST ONCE A YEAR.

## WIRING DIAGRAMS

These diagrams are provided for new installations or un-referenced wires.

### TYPICAL HEAT PUMP WITH AUX HEAT ALSO WIRED AS EMERGENCY HEAT

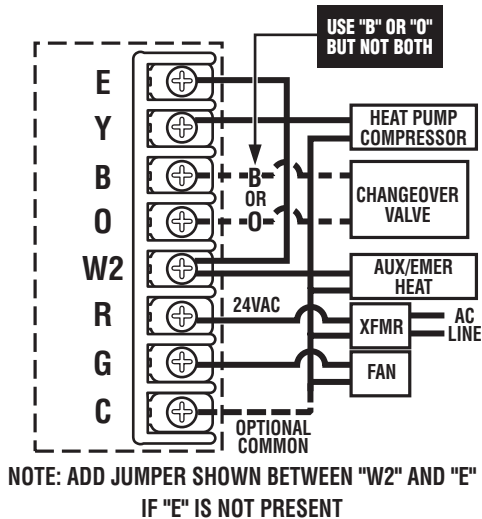

HEAT PUMP SYSTEM WITH COMMON TERMINAL	NEW THERMOSTAT AND CORRESPONDING TERMINALS								TAPE OFF (NOT USED)	
	E	G	Y	R	O	W2	B	C	L	
ARCO / Friedrich	X2	G	Y	RC		W2	B	C	L	
ARCO / Snyder General	E	G	Y	R	O	W1		C	X	
BARD	E	G	Y1	R		W2	B	X	L	
BARD, HP, WH, MHP, HPQ	E	G	Y	R		W2	W1	X	L	
BDP / BRYANT	E	G	Y	R	O	W1		C	F	
CARRIER	E	G	Y	R	O	Y1		C	L	
CARRIER 5Q	to W2	G	Y, W1	R	O	W2		C	L	
CARRIER 50Q, QT382	E	G	Y	R	O	W2		C	L	
COLEMAN		G	Y	RED	V	W2		BLCK		
COMFORTMAKER	E	G	Y	R	O	W2		X		
GE BAY	X2	G	Y	R	O	W		B		T
HEIL-QUAKER / Whirlpool		G	Y	R	O	W		B		
JANITROL / Goodman	E	G	Y	R	O	W2		C		
LENOX TYPICAL HP6		F	M	V/VR	R	Y		X		
LENOX HP8	E	F	M	V/VR	R	Y		X		
LENOX HP9, 10	E	F	M	V/VR	R	Y		X	L	
LENOX HP16, 18, 19	E	F	M	V/VR	R	Y		X	L	
MAGIC CHEF PE	E	G	Y	R	O	W		C		
PAYNE		G	Y/Y2	R	O/W2	W/W1		C		
RHEEM / RUUD	E	G	Y	R		W2	B	X	L	
SNYDER GENERAL H-R811/Y594R1375		G	Y	R	O	W1		C		
TRANE	X2	G	Y	R	O	W		B	F	T
WEATHERKING		G	W1	R	Y1	E		C		
WESCO	E	G	W1	R	Y1	W2		C		
WESCO / ADDISON	E	G	W1	R	O			X		
WESTINGHOUSE H50	E	G	Y	R	O	W		X		II
WESTINGHOUSE HE		F	C	V/VR		H2	Z	X		
WHITE RODGERS	E	G	Y	R	O	W2		C	L	
WHITE RODGERS	E	G	Y	R	O	W2		X1		
YORK		G	Y	R	O	W		B	X	

Important: Use either the B or O terminal, never both.

# TECHNICAL SERVICE

If you have any problems installing or using this thermostat, please reread the instructions carefully. Technical Service is available through our Technical Assistance Dept. If you require assistance, please call our offices between 8:00 a.m. and 4:30 p.m. Eastern Standard Time, Monday through Friday. The number is (856) 234-8803 or visit our online technical support at [www.luxproducts.com](http://www.luxproducts.com).

# WARRANTY

**Limited Warranty:** If this unit fails because of defects in materials or workmanship within one year of date of original purchase, LUX will, at its option, repair or replace it. This warranty does not cover damage by accident, misuse, or failure to follow installation instructions. Implied warranties are limited in duration to one year from date of original purchase. Some states do not allow limitations on how long an implied warranty lasts, so the above limitation may not apply to you. Please return malfunctioning or defective units to the participating retailer from which purchase was made, along with proof of purchase. Please refer to Technical Service Section before returning thermostat. Purchaser assumes all risks and liability for incidental and consequential damage resulting from installation and use of this unit. Some states do not allow the exclusion of incidental or consequential damages, so the above exclusion may not apply to you. This warranty gives you specific legal rights and you may also have other rights which vary from state to state. Applicable in the U.S.A. only.