

# 1 For All Programmable Digital Thermostat

---

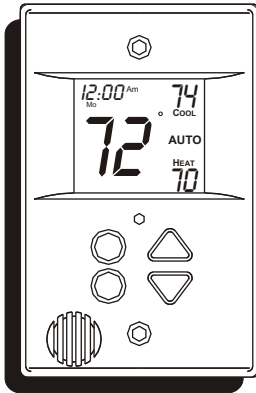

- Mounts Flush to the Wall
- 7 Day Programmable
- 3 Occupied, 1 Unoccupied
- Auto Changeover
- Large, Easy To Read Display
- Thermoglow™ Backlight
- Remote Sensor Ready
- Dry Contact Equipped
- Energy Saving Smart Fan
- Fan Purge, IAQ Feature
- Includes Locking Cover

Meets California Title 24

Both Commercial & Residential

- 
- Use with most Air Conditioning & Heating Systems including: 1 or 2 Stage Electric Cooling & Gas Heating, Heat Pump, Electric or Hydronic Heat.

## TOTALINE

*FlatStat*

## Table Of Contents

<b>FRONT PANEL</b>	2
<b>DISPLAY</b>	3
<b>QUICK START</b> <i>Set the clock and go</i>	5
<b>BASIC OPERATION</b>	6
<b>PROGRAMMING</b> <i>Occupied / Unoccupied</i>	8
<b>ADVANCED SETUP</b>	12
<b>ABOUT ADVANCED OPERATION</b>	17
<b>WARRANTY</b>	23



### CAUTION

Follow Installation Instructions before proceeding.

SET THERMOSTAT TO MODE "OFF" PRIOR TO  
CHANGING SETTINGS IN SETUP OR RESTORING  
FACTORY DEFAULTS.

---

Replacement Components Division © Carrier Corporation 11/98

**P/N P374-2300FM**

## Front Panel

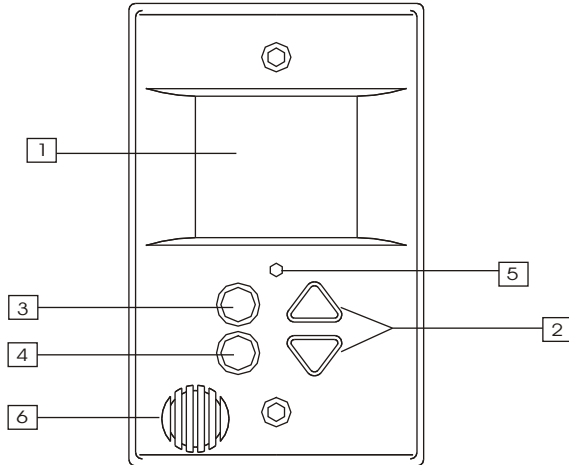

1 **Liquid Crystal Display**  
*with Thermoglow™*

2 **Up/Down Buttons**

3 **Mode Button**

4 **Override Button**

5 **Heat or Cool Indicator**  
Heat = Red, Cool = Green

6 **Temperature Sensor Bubble**

## Display

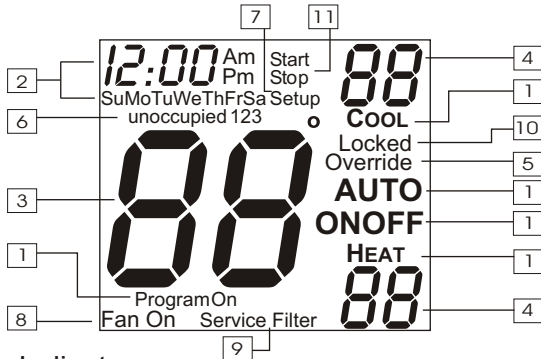

### 1 Mode Indicators

Selects the operation mode of the equipment.

**HEAT** - indicates the heat mode.

**COOL** - indicates the air conditioning mode.

**AUTO** - indicates the system will automatically changeover between heat and cool modes as the temperature varies.

**OFF** - indicates the entire system is turned off.

**PROGRAM ON** - indicates the stored program is enabled to run. *Page 6.*

### 2 Clock with Day of the Week

Indicates the current time and day. This clock is also used to program the timer periods. *Page 5.*

### 3 Room Temperature Display

Indicates the current room temperature.



### 4 Desired Set Temperature

Indicates desired room temperature(s). *Page 7.*

## Display

- 5 Override Indication  
Indicates the current program is currently being overridden for up to 4 hours. *Page 7,17.*
- 6 Occupied or Unoccupied Indication  
Indicates the program number: Occupied 1,2,3, or Unoccupied. *Page 8-11.*
- 7 Setup Indication  
Indicates the thermostat is in the programming mode. *Page 12.*
- 8 Fan Operation Indication  
**Fan On** - indicates constant, continuous fan operation.  
When **Fan On** is not lit - indicates the fan will only operate when necessary to heat or to cool. *Page 12.*
- 9 Service Filter Indication  
**Service Filter** indicates when the filter should be serviced under normal conditions.  
Appears after 0 - 1950 hours of blower operation (adjustable). *Page 14.*
- 10 Locked Indication  
**Locked** appears after the right combination of buttons are pressed, rendering the buttons inoperative. *Page 19.*
- 11 **Start / Stop** Indication  
Start or Stop appears when programming timer functions. *Page 9.*

## Quick Start *Set the Clock and Go*

**MODE**   
**OVERRIDE** 

**Press the Mode button. While holding the Mode, press the Override button for 2 seconds to enter Setup screens.**

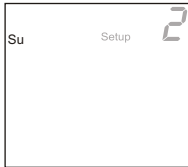
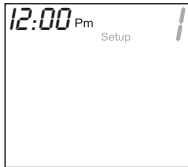

**Press both Mode and Override buttons as above to return to normal operation.**

**MODE**   
**OVERRIDE** 

*During Setup & Programming: Pressing the Mode button selects different flashing items. (Represented in dark black)*

*Pressing the Up and Down buttons will modify the flashing selection.*

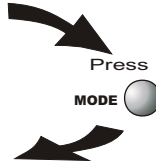

To adjust the clock or Day use



buttons.



The thermostat is preprogrammed from the factory to operate 1 or 2 Stage equipment\* without the need for further programming. To optimize the installation of this thermostat follow the instructions in the Advanced Setup section.

*\* The thermostat is not preprogrammed from the factory to operate electric heat or heat pump systems. To control these systems, follow the steps in the Advanced Setup section, pages 12 & 13.*

## Basic Operation

### Select Mode

The **HEAT** setting indicates the temperature the room has to reach before the furnace will turn on to heat the room.

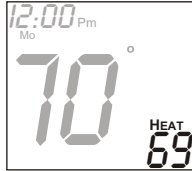

The **COOL** setting indicates the temperature the room has to reach before the air conditioner will turn on to cool the room.



**AUTO** will automatically select heat or cool based on room temperature demand.

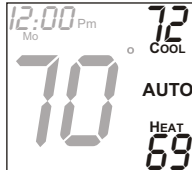

**Program On** will activate the stored timer operation. (occupied & unoccupied periods.)

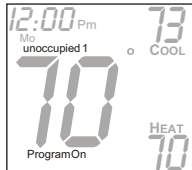

**OFF** indicates both heating and air conditioning systems are turned off.

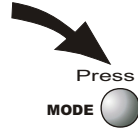

## Basic Operation

### Select Desired Temperature

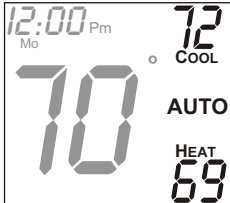

In any mode, adjust the desired Set Temperature with



buttons.

Pressing the up/down buttons in Auto mode will adjust **both** the heat and cool set temperatures simultaneously.

Pressing the up/down buttons in Heat or Cool modes will adjust only the heat or cool set temperature.

### Override

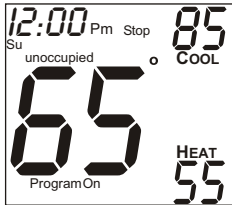

During programmed, unoccupied periods a press of the Override button will force the thermostat into Occupied 1 comfort settings, temporarily.

With each successive push of the Override button, the override timer will add 30 minutes, until the maximum of 4 hours is reached. Then the next press will zero out the override timer, returning to unoccupied if there are no further button presses.

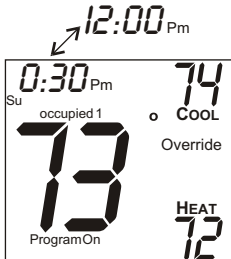

When in Override, the Override icon and the Occupied 1 icon appear on the display.

The time of day clock alternates with the time remaining in override.

During Override, the setpoints are adjustable, provided the keypad is not locked.



# Programming

# Occupied & Unoccupied Periods



**Press the Mode button. While holding the Mode, press the Up button for 2 seconds to enter time period programming.**



Select the maximum # of occupied periods to be used on any one day. Typically 1.

(1,2 or 3)

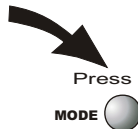

Adjust the cooling setpoint for occupied 1.

(35 - 99°)



Adjust the heating setpoint for occupied 1.

(35 - 99°)

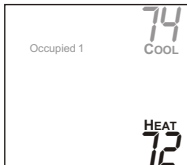

Adjust the cooling setpoint for unoccupied periods.

(35 - 99°)

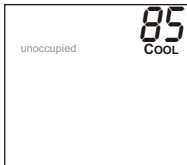

# Programming

# Occupied & Unoccupied Periods



Adjust the heating set-point for unoccupied periods.  
(35 - 99)

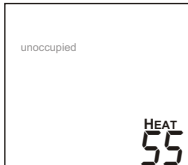

Select the day for Occupied 1.  
(M - S)



Adjust the start time for occupied 1.

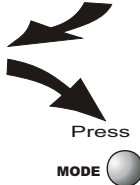
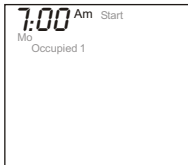

Adjust the stop time for occupied 1.

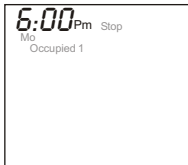

*On*  
Select Occupied 1 to run on this day (On), or not to run this day (Off).  
*Off*

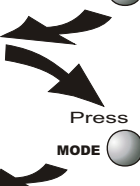

# Programming

# Occupied & Unoccupied Periods

The copy command becomes available after the maximum # of occupied periods are programmed in a day. This example uses 1 as the maximum occupied periods ever programmed in one day.

Yes  
Select Yes or No to copy the previous day's program to this day.  
No

If Yes is selected:

Press **MODE**

If No is selected:

Press **MODE**

Selecting Yes, then pressing mode will copy the previous day's program and then will ask the same copy question again. If yes is selected each time, this routine will repeat until Saturday is copied to Sunday. After Saturday is copied to Sunday, the copy command is unavailable.

Select the day for Occupied 1.  
(T - M)

Press **MODE**

Adjust the start time for occupied 1.

Press **MODE**

Adjust the stop time for occupied 1.

Press **MODE**

## Programming

## Occupied & Unoccupied Periods



On

Select Occupied 1 to run on this day (On), or not to run this day (Off).

Off

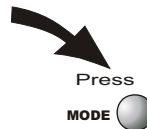

Press

MODE



Yes

Select Yes or No to copy the previous day's program to this day.

No

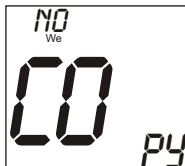

If Yes is selected:

Press



Selecting Yes, then pressing mode will copy the previous day's program and then will ask the same copy question again. If yes is selected each time, this routine will repeat until Saturday is copied to Sunday. After Saturday is copied to Sunday, the copy command is unavailable.

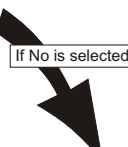

If No is selected:

Press

MODE

If no is selected, as in previous steps flashing prompts for input will appear for start and stop times for Occupied 1. If more than one occupied period was selected in step 1 on page 8, then cool/heat setpoints, and start/stop times for additional occupied periods will be prompted.

### PROGRAMMING NOTES

- \* If only 1 Occupied period is selected in step 1 on page 8, Occupied 2 & 3 programming steps are skipped. Further, if only 2 occupieds are selected, Occupied 3 programming steps are skipped.
- \* Heat & Cool setpoints for Occupied 1 are the same for every day of the week. Heat & Cool setpoints for Occupied 2 & 3 can be adjusted differently for each day of the week, if desired.
- \* If the start time is set later in the day than the stop time, the program will run from the start time to midnight and from midnight to the stop time on the same day. For example: 9:00pm start, 8:00am stop, on Monday. In this example the program will run from 12:00am Monday to 8:00am Monday and again from 9:00pm Monday to 12:00pm Monday.
- \* The Unoccupied settings take effect at all times when: (1) the program is on and (2) the current time is outside a preset occupied period. For this reason start and stop times aren't necessary for unoccupied.
- \* If the same start and stop times are programmed in for an occupied period, then it will run 24 hours.
- \* If one occupied period starts and stops within another occupied period the lower occupied # has priority. For example: If Occupied 3 is programmed to be "on" 24 hours, and Occupied 2 is programmed to run that day, then Occupied 2 settings will take over from Occupied 3 between Occupied 2 start and stop times.

# Advanced Setup

**MODE** 

**Press the Mode button. While holding the Mode, press the Override button for 5 seconds to enter Setup screens.**

**OVERRIDE** 

**NOTE:** Each step # is located at the top right corner of the display for easy reference.



Adjust the time of day clock.

*Tip: To change hours quickly, press and hold the override button in and press the up or down buttons.*

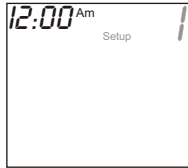

Press 



Select the day of the week.

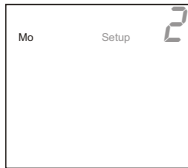

Press 



*Fan On*

Select fan operation, Fan On or Fan Auto.

*Fan Auto*

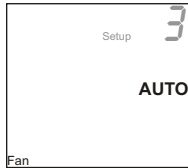

Press 



*On*

Select residential Heat Pump, On or Off.

*Off*



Press 

# Advanced Setup



B  
Select the reversing valve polarity for Heat Pump, O or B.  
(Step 5 only appears if heat pump is **on** in step 4)  
O

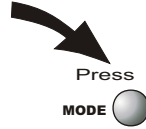

On  
Select Electric Heat On or Off. (Step 6 only appears if heat pump is **off** in step 4)  
Off



Adjust the deadband from 1 - 6 degrees.



Adjust the minimum **difference** between cooling & heating setpoints.  
(0 - 6°)

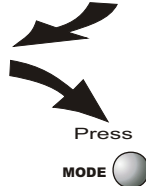
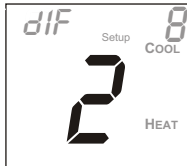

Select the cycles per hour limit.  
d=cycles per hour limit defeated.  
d1=d + defeat 5 min.  
Compressor lockout.  
(d, d1, 2 - 6)

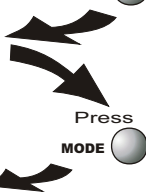

# Advanced Setup



Adjust the preoccupancy fan purge timer.  
0 - 3 hours.  
0:00 = off

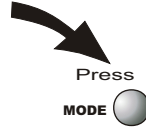

*On*  
Select the display back-light always **On**, or **Off** after 8 seconds.  
*Off*



**OVERRIDE**

Reset the Service Filter counter to 0, to remove the icon from the display.

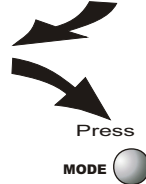
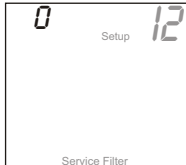

Adjust the number of hours the blower will run before the Service Filter icon appears on the display. 0 = off.  
(0 - 1950)

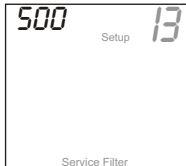

Select the unit ID for 'Soft Start'. This is used in multiple installs to stagger equipment turn on times. 0 = off. Each # = 30 second delay.  
(0 - 99)

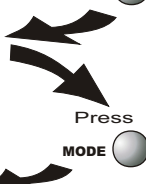

# Advanced Setup



C  
 Select thermostat operation in degrees Fahrenheit or Centigrade.  
 F



MODE



Yes  
 Select the sensor type:  
 Yes = Outside or Duct sensor  
 No = Automatic Detection of Remote Sensor  
 No



MODE



Select the security level:  
 0=no security in effect  
 1=setpoint range limited  
 2=1+ program on all times  
 3=2 + prohibits setpoint changes

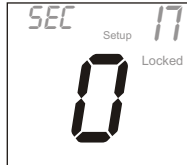

MODE



Adjust the maximum allowable heat setpoint when security is in effect.  
 (Step 18 only appears if step 17 is not 0).

(35 - 99)

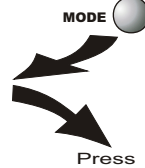
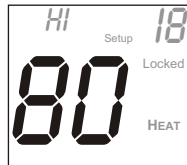

MODE

Continued



## Advanced Setup



Adjust the minimum allowable cool setpoint when security is in effect. (Step 19 only appears if step 17 is not 0).

(35 - 99)

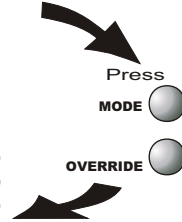

Press the Mode button. While holding the Mode, press the Override button for 2 seconds to leave the Setup screens. If no buttons are pressed, the display will leave the setup screens after 30 seconds.

## Advanced Setup Table

Step #	Description	Range	Factory Default
1	Time of day clock set	24 hour	12:00 Am
2	Day of the week	Sun - Sat	Monday
3	Fan operation	Auto / On	Auto
4	Heat Pump	Off / On	Off
5	Reversing Valve polarity	O / B	O
6	Electric Heat	Off / On	Off
7	Deadband or Temperature swing	1 - 6	2
8	Forced minimum difference heat/cool	0 - 6	2
9	Cycles per hour	d, d1, 2 - 6	6
10	Fan Purge timer	0:00 - 3:00	0:00
11	Thermoglow backlight	Off / On	On
12	Reset Service Filter icon	--	--
13	Service Filter run time set	0 -1950	500
14	Soft Start	0 - 99	0
15	Fahrenheit or Centigrade	F / C	F
16	Outside/Duct Sensor	Yes / No	No
17	Security Levels	0 - 3	0
18	Maximum allowable Heat setpoint	35 - 99	80
19	Minimum allowable Cool setpoint	35 - 99	65

## About Advanced Features & Operation

- \* **CLOCK BACKUP** - In the event of a power loss, the thermostat internal clock will continue to keep proper time for a minimum of 48 hours without external power or batteries.
- \* **2 STAGE OPERATION** - The 2nd Stage of heat or cool is turned on when **(1)** the 1st Stage has been on for a minimum of two minutes, **and (2)** the temperature spread from the setpoint is equal to or greater than: *the setpoint plus the deadband, plus 2 degrees.*

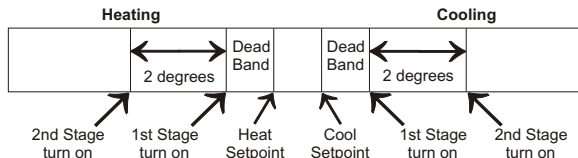

- \* **MINIMUM HEAT/COOL SETPOINT DIFFERENCE** - The Heat and Cool setpoints will not be allowed to come any closer to each other than the value set in Advanced Setup *step # 8, on page 13*. This minimum difference is enforced during Auto changeover and Program On operation.
- \* **ENERGY SAVING SMART FAN** - If Fan On is selected, *page 12, step 3*, the fan will run continuously at all times, except in Off, **and** will only run if there is a heating or cooling demand in Unoccupied periods.
- \* **OVERRIDE** - As explained on *page 7*, pressing the Override button during a programmed, Unoccupied period will force the thermostat into Occupied 1, temporarily, up to 4 hours. If the Override button is pressed during an Occupied period, the thermostat will be forced into Unoccupied and the occupied # (1,2 or 3), it was forced out of will be turned off, only for that day. During Override periods the setpoints may be adjusted, but they will not be remembered after Override ends.

## About Advanced Features & Operation

- \* **FAN PURGE TIMER** - When this feature is activated, the fan will turn on during Unoccupied at a preset amount of time prior to Occupied 1. This preoccupation fan purge timer may be set as instructed on *page 14, step #10*, from 0 - 3 hours. 0 = this feature turned off.
- \* **EMERGENCY HEAT** - Is a feature available to Heat Pump installations. To turn on Emergency Heat press in the Override button. While holding the Override button press the Up button for 2 seconds. The Cool setpoint display will read 'EH'.

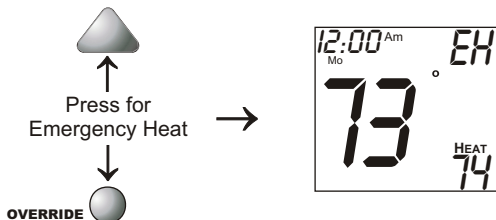

During Emergency Heat the thermostat will turn on the fan and the 2nd stage of heat, when there is a demand for heat, locking out the 1st stage compressor. Exiting Emergency Heat is the same as entering. During Emergency Heat only OFF and HEAT are available.

- \* **ELECTRIC HEAT** - Selecting Electric Heat on, *page 13, step 6*, will cause the thermostat to turn on the fan immediately any time there is a heat demand. Since all gas furnaces control the fan, this feature should be off unless the heater is only electric.

## About Advanced Features & Operation

- \* **KEYPAD LOCK** - To prevent unauthorized use of the thermostat, the front panel buttons may be disabled. To disable, or 'lock' the keypad, press and hold in the Mode button. While holding the Mode button in, press the Up and Down buttons in together. The **Locked** icon will appear on the display.

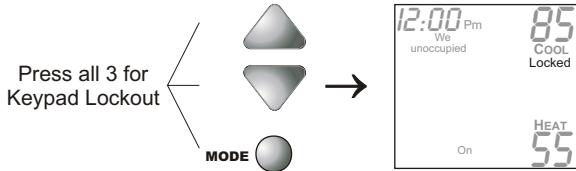

To **unlock** the buttons, again press and hold the Mode button. While holding the Mode button in, press the Up and Down buttons in together. The **Locked** icon will disappear from the display.

- \* **DRY CONTACT SWITCH** - The terminals are 'normally open'. Closing or completing the circuit will cause the thermostat to enter Occupied 1. This feature allows an external device such as a Central Time Clock, Occupancy Sensor, or a Telephone activated device to force 1 or more thermostats into Occupied 1. For the Dry Contact to work the thermostat must be in **Program On**. *Set Occupied 1 to Off for all 7 days*, so the Contact closure will be in control. When the thermostat is forced into Occupied 1 via the Dry Contact closure, the icon **Occupied 1** will blink.

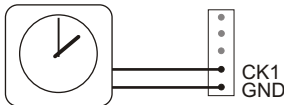

**Important Note:** For control of *multiple thermostats by 1 source*, refer to document P/N 88-175 'Potential Phasing Problems' before installation.

## About Advanced Features & Operation

- \* **HOLIDAY MODE** - This feature forces the thermostat into Unoccupied for a preset duration, up to 99 days. The Holiday setup display is entered as follows:

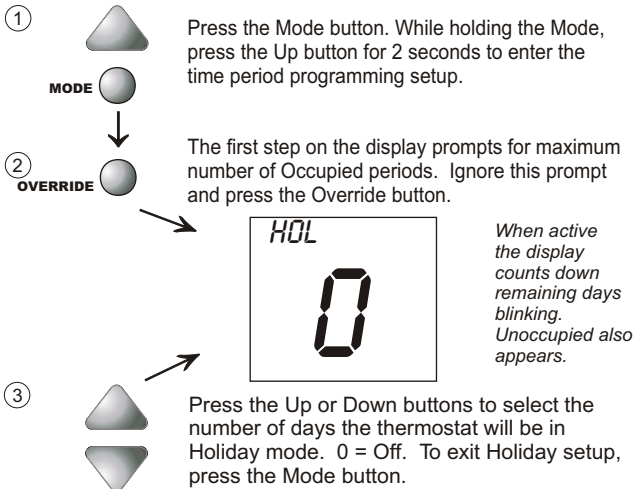

The thermostat will enter the Holiday mode when the clock crosses midnight.

During Holiday mode Unoccupied setpoints are enforced.

The Override button is active during Holiday mode. It will override to Occupied 1 settings up to 4 hours then return to Holiday mode. The Dry Contact Switch is ignored.

The thermostat will exit Holiday mode at midnight of the final programmed day. To terminate Holiday immediately, enter the Holiday setup screen and select 0.

## About Advanced Features & Operation

- \* **SOFT START** - This feature is utilized in multiple thermostat installations controlled by the Dry Contact terminals. Assigning a unique Soft Start number to each thermostat will stagger the turn on times, even though the Dry Contact closes, for all the thermostats connected, at the same time. Each Soft Start number represents a multiple of 30 seconds from the Dry Contact closure. For example, #1 = turn on 30 seconds after Dry Contact closure, #2 = turn on 60 seconds after closure, #3 = turn on 90 seconds after closure, and so on. See *page 14, step 14*, to configure the thermostat for Soft Start.
- \* **DUAL SETPOINT BEHAVIOR** - The adjustable setpoint range is: 35 - 99 degrees in Fahrenheit and 7 - 35 degrees in Centigrade. When in the modes Heat or Cool, this adjustable range is unhampered. When adjusting any Auto mode, including programming Occupied and Unoccupied periods, the thermostat will not allow the Heat setpoint to get closer to the Cool setpoint than the value programmed as the minimum difference in *step 8, page 13*.  
When entering the Auto mode from Cool, the Heat and Cool setpoints will remain spread apart by the amount that they were adjusted, prior to entering Auto. For example: If the Cool setpoint was set to 80 while in the Cool mode and the Heat setpoint was adjusted to 70 while in the Heat mode, upon entering the Auto mode the Heat and Cool setpoints would be 80 and 70. **Both** setpoints would then move up and down together, (in this example spread by 10 degrees), by pressing the up or down buttons.  
To move the Heat and Cool setpoints closer together, enter the Cool or Heat mode by pressing the Mode button, then adjust the setpoint(s) closer together. Heat is limited to how close it can come to Cool by *step 8, page 13*.

## About Advanced Features & Operation

- \* **REMOTE SENSORS (Optional Accessory)** - When connected to terminals RS+5, RS, & GND on the back of the thermostat, it will read the temperature from the Remote Sensor and ignore the temperature sensor inside the thermostat. The thermostat automatically recognizes when a Remote Sensor is connected (setup step #16-**No**). When reading the temperature from the remote, the degree icon above the room temperature blinks once a second.



Optional R.F. Sensor



Optional Remote Sensor

**The Override button** on the Remote Sensor works slightly different than the Override button on the front panel. Each press of the 'External' Override button adds 2 hours to the override timer. If the timer was already active, the first button press will round the runtime to either 2:00 or 4:00.

Subsequent button presses will not wraparound as the Override button on the thermostat does, so the 2nd or greater button press will set the runtime to 4:00. The Locked feature has no effect on the external Override button. The *wired* Remote Sensor is connected to the thermostat with **up to 500' of 20 ga. or 300' of 18 ga. thermostat wire**. See the Remote Sensor instructions for further details.

- \* **FACTORY DEFAULTS** - If, for any reason it is desirable to return all stored settings back to the factory default settings, press the Mode button. While holding the Mode button in, press the Down button for 2 sec. All icons will appear. Press and hold in the Override button until **Fd** appears. This resets all factory settings. **To calibrate room temperature**, press the Mode button once more. At this point use the Up and Down buttons to calibrate room temperature, if needed. Press the Mode button to return to normal operation. **NOTE CAUTION ON PAGE 1.**

# Warranty

**One-Year Warranty** - This Product is warranted to be free from defects in material and workmanship. If it appears within one year from the date of original installation, whether or not actual use begins on that date, that the product does not meet this warranty, a new or remanufactured part, at the manufacturer's sole option, to replace any defective part will be provided without charge for the part itself: PROVIDED the defective part is returned to the distributor through a qualified servicing dealer.

THIS WARRANTY DOES NOT INCLUDE LABOR OR OTHER COSTS incurred for diagnosing, repairing, removing, installing, shipping, servicing or handling of either defective parts or replacement parts. Such costs may be covered by a separate warranty provided by the installer.

THIS WARRANTY APPLIES ONLY TO PRODUCTS IN THEIR ORIGINAL INSTALLATION LOCATION AND BECOMES VOID UPON REINSTALLATION.

**LIMITATIONS OF WARRANTIES** - ALL IMPLIED WARRANTIES (INCLUDING IMPLIED WARRANTIES OF FITNESS FOR A PARTICULAR PURPOSE AND MERCHANTABILITY) ARE HEREBY LIMITED IN DURATION TO THE PERIOD FOR WHICH THE LIMITED WARRANTY IS GIVEN. SOME STATES DO NOT ALLOW LIMITATIONS ON HOW LONG AN IMPLIED WARRANTY LASTS, SO THE ABOVE MAY NOT APPLY TO YOU. THE EXPRESSED WARRANTIES MADE IN THIS WARRANTY ARE EXCLUSIVE AND MANY NOT BE ALTERED, ENLARGED, OR CHANGED BY ANY DISTRIBUTOR, DEALER, OR OTHER PERSON WHATSOEVER.

ALL WORK UNDER THE TERMS OF THIS WARRANTY SHALL BE PERFORMED DURING NORMAL WORKING HOURS. ALL REPLACEMENT PARTS, WHETHER NEW OR REMANUFACTURED, ASSUME AS THEIR WARRANTY PERIOD ONLY THE REMAINING TIME PERIOD OF THIS WARRANTY.

THE MANUFACTURER WILL NOT BE RESPONSIBLE FOR:

1. Normal maintenance as outlined in the installation and servicing instructions or owners manual including filter cleaning and/or replacement and lubrication.
2. Damage or repairs required as a consequence of faulty installation, misapplication, abuse, improper servicing, unauthorized alteration or improper operation.
3. Failure to start due to voltage conditions, blown fuses, open circuit breakers or other damages due to the inadequacy or interruption of electrical service.
4. Damage as a result of floods, winds, fires, lightning, accidents, corrosive environments or other conditions beyond the control of the Manufacturer.
5. Parts not supplied or designated by the Manufacturer, or damages resulting from their use.
6. Manufacturer products installed outside the continental U.S.A., Alaska, Hawaii, and Canada.
7. Electricity or fuel costs or increases in electricity or fuel costs from any reason whatsoever including additional or unusual use of supplemental electric heat.
8. ANY SPECIAL INDIRECT OR CONSEQUENTIAL PROPERTY OR COMMERCIAL DAMAGE OF ANY NATURE WHATSOEVER. Some states do not allow the exclusion of incidental or consequential damages, so the above may not apply to you.

This warranty gives you specific legal rights, and you may also have other rights which may vary from state to state.