



TRUE COMFORT IIII

This manual covers the following models:

- T771

Thermostat Applications Guide

Description	
Gas or Oil Heat	Yes
Electric Furnace	Yes
Heat Pump (No Aux. or Emergency Heat)	No
Heat Pump (with Aux. or Emergency Heat)	No
Multi-stage Systems	No
Heat Only Systems	Yes
Heat Only Systems - Floor or Wall Furnaces	Yes
Cool Only Systems	Yes
Millivolt	Yes

Power Type

- Battery Power
- Hardwire (Common Wire)
- Hardwire (Common Wire) with Battery Backup

Table of Contents

	Page
Installation Tips	2
Thermostat Quick Reference	3
Subbase Installation	4
Wiring	5
Wiring Diagrams	6
Technician Setup	7
Mounting and Battery Installation	8
Specifications	9

A trained, experienced technician must install this product.

Carefully read these instructions. You could damage this product or cause a hazardous condition if you fail to follow these instructions.

Need Help?

For assistance with this product please visit <http://www.pro1iaq.com> or call Pro1 Customer Care toll-free at 888-Pro1iaq (776-1427) during normal business hours (Mon-Fri 9 AM - 6 PM Eastern)

Una versión española de este manual puede ser descargada en www.pro1iaq.com

Wall locations

The thermostat should be installed approximately 4 to 5 feet above the floor. Select an area with average temperature and good air circulation.

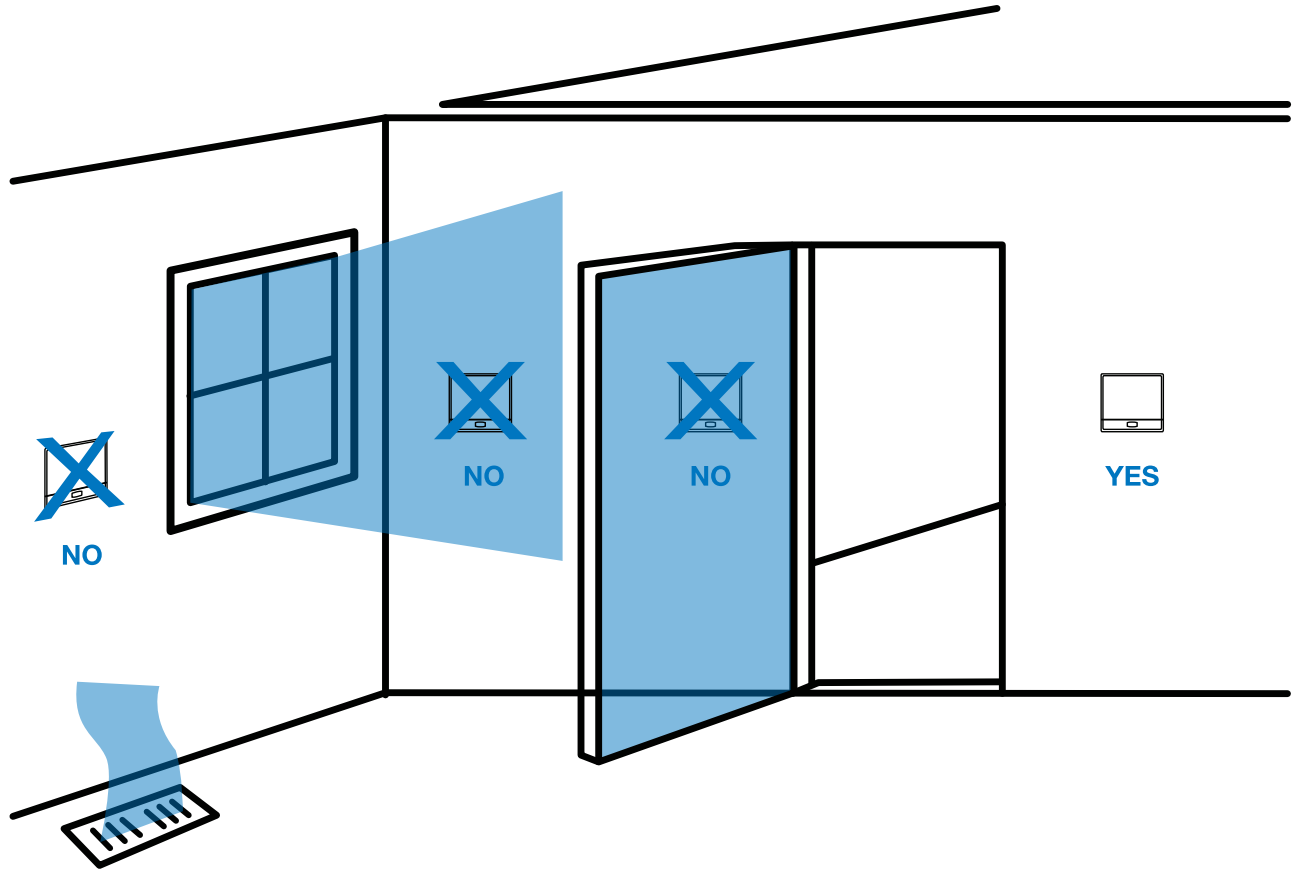

Do not install thermostat in locations:

- Close to hot or cold air ducts
- That are in direct sunlight
- With an outside wall behind the thermostat
- In areas that do not require conditioning
- Where there are dead spots or drafts (in corners or behind doors)
- Where there might be concealed chimneys or pipes

PRO1 Tip

Pick an installation location that is easy for the user to access. The temperature of the location should be representative of the building.

Getting to know your thermostat

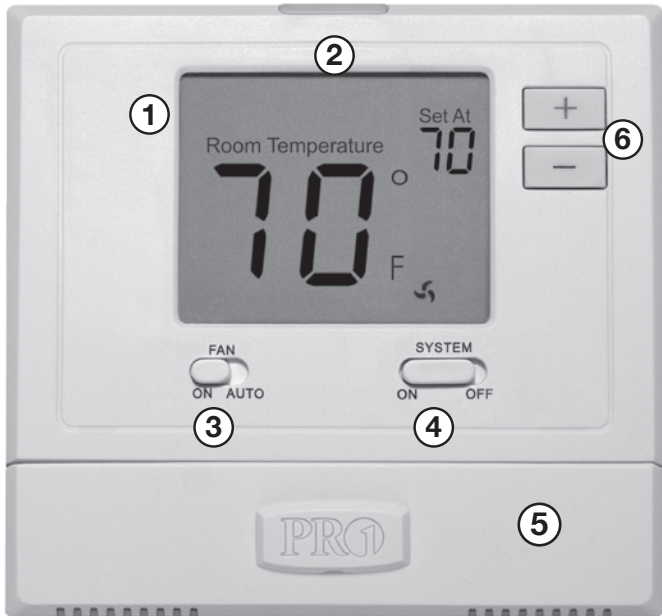

- ② Glow in the Dark Light Button
- ③ Fan Switch
- ④ System Switch
- ⑤ Easy Change Battery Door
- ⑥ Temperature Setpoint Buttons

① LCD

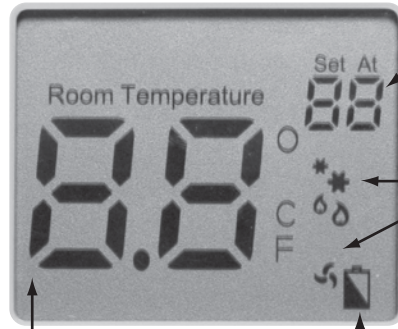

Displays the user selectable setpoint temperature.

System operation indicators:

** COOL 🔥 HEAT 🌀 FAN

The **COOL**, **HEAT** or **FAN** icon will display when the **COOL**, **HEAT** or **FAN** is on. **NOTE:** The compressor delay feature is active if these icons are flashing. The compressor will not turn on until the 5 minute delay has elapsed.

Low Battery Indicator: Replace batteries when indicator is shown.

Indicates the current room temperature.



Important:

The low battery indicator is displayed when the AA battery power is low. If the user fails to replace the battery within 21 days, the thermostat display will only show the low battery indicator as a final warning before the thermostat becomes inoperable.

NOTE: In applications where the thermostat will see temperatures below 40 degrees it is recommended that 1.5V AA lithium batteries be used instead of alkaline for increased battery life. (Extreme temperatures decrease the life of Alkaline batteries.)

Removing the private label badge

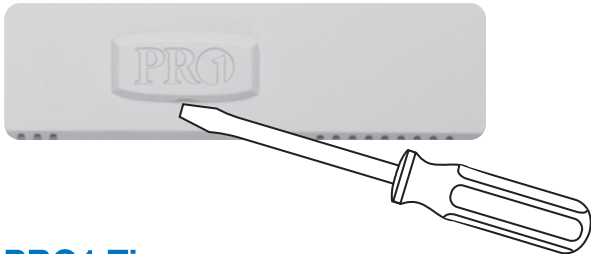

Use the bevel on lower ridge

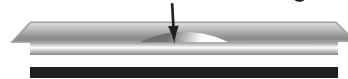

Magnet in door ↑

Gently slide a screwdriver into the bottom edge of the badge. Gently turn the screwdriver counter clockwise. The badge is held on by a magnet in the well of the battery door. The badge should pry off easily.

Do not use force.

PRO1 Tip

All Pro1 thermostats use the same universal magnetic badge. Visit our website at www.pro1iaq.com to learn more about our free private label program.



Caution:
Electrical Hazard

Failure to disconnect the power before beginning to install this product can cause electrical shock or equipment damage.



Mercury Notice:

All of Pro1's products are mercury free. However, if the product you are replacing contains mercury, dispose of it properly. Your local waste management authority can give you instructions on recycling and proper disposal.

For vertical mount put one screw top and one screw bottom.

For horizontal mount put one screw left and one screw right.

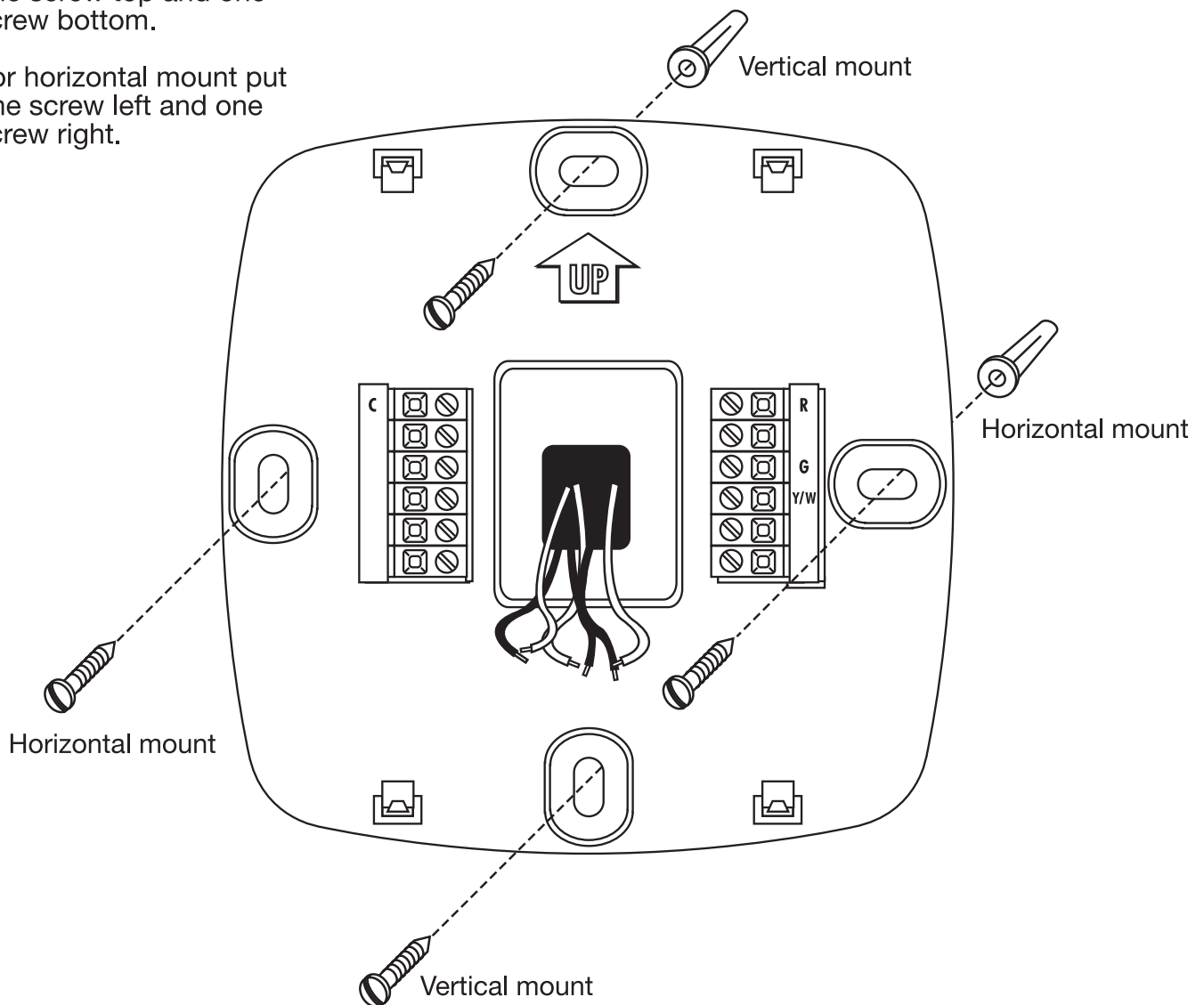

Wiring

1. If you are replacing a thermostat, make note of the terminal connections on the thermostat that is being replaced. In some cases the wiring connections will not be color coded. For example, the green wire may not be connected to the **G** terminal.
2. Loosen the terminal block screws. Insert wires then retighten terminal block screws.
3. Place nonflammable insulation into wall opening to prevent drafts.



Warning:

All components of the control system and the thermostat installation must conform to Class II circuits per the NEC Code.

Terminal Designations

Y/W Heat relay or Compressor relay

G Fan relay

R Transformer power for cooling or heating

1 Power supply

2 Optional 24 VAC common connection when thermostat is used in battery power mode

C Common wire from system transformer

Typical heat-only system with fan

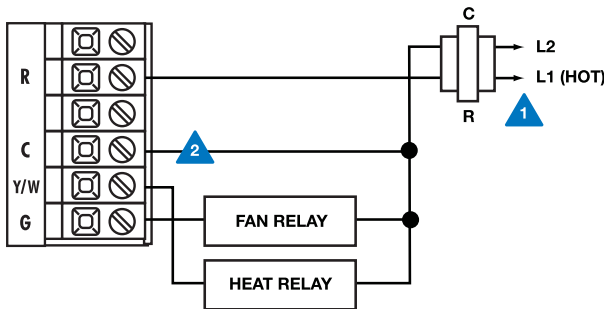

Typical heat-only system

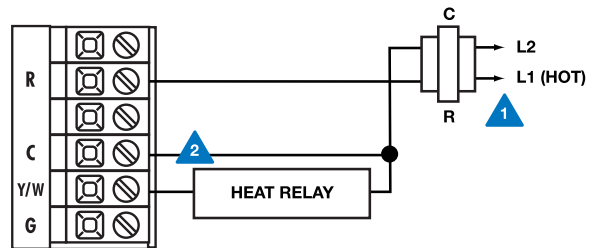

Typical cool-only system

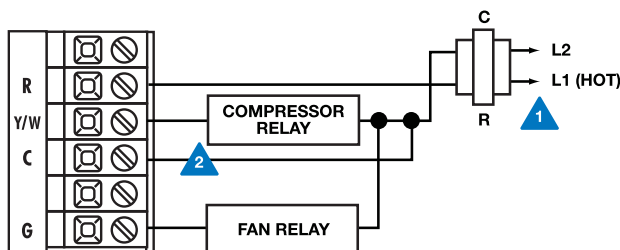

PRO1 Tips:

C terminal

The C (common wire) terminal does not have to be connected when the thermostat is powered by batteries.

Wire specifications

Use shielded or non-shielded 18 - 22 gauge thermostat wire.

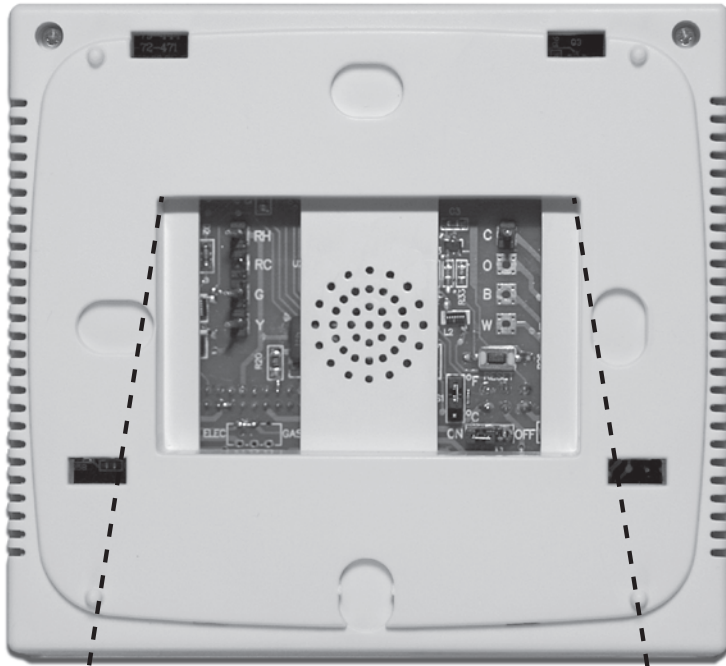

Fahrenheit/Celsius Display

Select **F** or **C** with the jumper pin on the back of the thermostat.

Delay

The compressor delay will not allow the compressor to be turned on for 5 minutes after the last time the compressor was on. The cooling icon will flash during the delay period. Select **OFF** or **ON** with the jumper pin as desired.

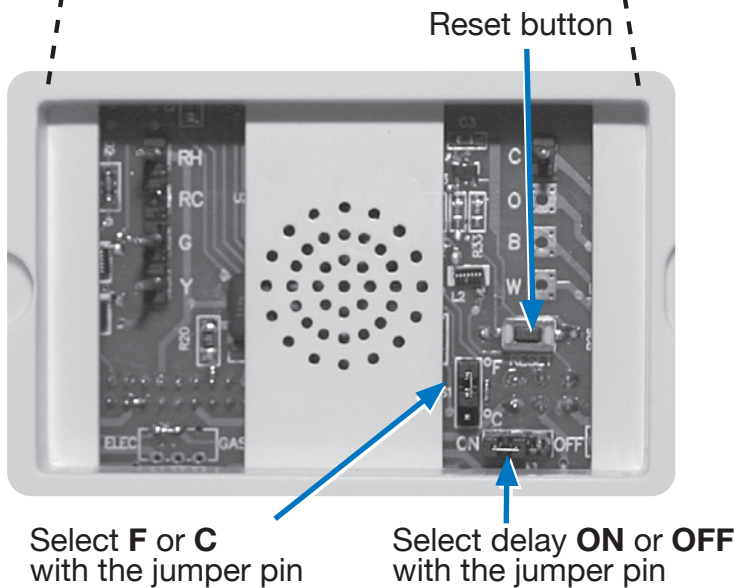

Important:

The **RESET** button must be pressed after changing any switch or jumper pin setting. Batteries must be installed for this operation.







Selecting Heat or Cool

1. Set system switch to on.
2. Hold down + and - key for 3 seconds to bring up the current mode.
3. Use + or - to select the mode.
4. Wait 10 sec for the thermostat to return to normal operation.

Technician Setup Menu

This thermostat has a technician setup menu for easy installer configuration. To set up the thermostat for your particular application:

1. Set system switch to off.
2. Hold down + and - key together for 3 seconds.
3. Configure the installer options as desired using the table below.
4. Use the + or - keys to change the options below and the **LIGHT** key to move from one step to another.

Tech Setup Steps			
Heat or Cool	Room Temperature Calibration	Swing	Temperature Setpoint Limit
<p>This feature allows the installer to configure the thermostat for Heat only or Cool only operation.</p> <p>(reference the Selecting Heat or Cool steps above for how to enter this Menu)</p>	<p>This feature allows the installer to change the calibration of the room temperature display. For example, if the thermostat reads 70° and you would like it to read 72° then select +2.</p> <p>(reference the Technician Setup Menu steps above for how to enter this Menu)</p>	<p>The swing setting, often called "cycle rate", "differential" or "anticipation" is adjustable. A smaller swing setting will cause more frequent cycles and a larger swing setting will cause fewer cycles.</p> <p>(reference the Technician Setup Menu steps above for how to enter this Menu)</p>	<p>This feature allows you to set a maximum heat setpoint value or a minimum cool setpoint value. The setpoint temperature cannot be changed past this value.</p> <p>(reference the Technician Setup Menu steps above for how to enter this Menu)</p>
LCD Will Show			
		 	 
Adjustment Options			
<p>This thermostat is configured for Heat only or Cool only operation.</p> <p>Select HE for Heat or CO for Cool.</p>	<p>You can adjust the room temperature display to read -4°F to +4°F above or below the factory calibrated reading.</p>	<p>The swing setting is adjustable from ±0.4°F to ±2°F. For example:</p> <p>For example, a swing setting of 0.5 will turn the system on and off at approximately 0.5° away from the setpoint. Only the swing for the selected mode (Heat of Cool) is displayed in the Menu.</p>	<p>Use the + or - key to select the maximum heat setpoint or the minimum cool depending on the selected mode (Heat of Cool).</p>
Factory Default Settings			
Heat	0 °F	0.4 Heat and 0.5 Cool	25° for cool and 90° for heat

PRO1 Tip

Temperature swing, sometimes called differential or cycle rate, can be customized for this individual application. For most applications choose a swing setting that is as long as possible without making the occupants uncomfortable.

INSTALLATION MANUAL

MOUNT THERMOSTAT & BATTERY INSTALLATION

Mount Thermostat

Align the 4 tabs on the subbase with corresponding slots on the back of the thermostat, then push gently until the thermostat snaps in place.



Battery Installation

Battery installation is optional if thermostat is hardwired (**C** terminal connected).

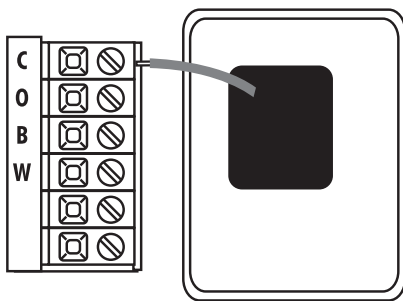

Replace with 2 AA 1.5v batteries.

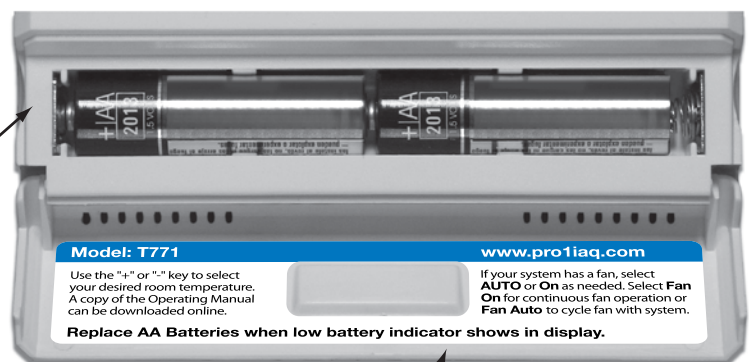

Simple operating instructions are found on the back of the battery door.

NOTE: In applications where the thermostat will see temperatures below 40 degrees it is recommended that 1.5V AA lithium batteries be used instead of alkaline for increased battery life. (Extreme temperatures decrease the life of Alkaline batteries.)

Specifications

The display range of temperature	20°F to 95°F (-6°C to 35°C)
The control range of temperature	25°F to 90°F (-4°C to 32°C)
Load rating	1 amp per terminal, 1.5 amp maximum all terminals combined
Display accuracy	± 1°F
Swing (cycle rate or differential)	Heating is adjustable from 0.4°F to 2.0°F Cooling is adjustable from 0.4°F to 2.0°F
Power source	18 to 30 VAC, NEC Class II, 50/60 Hz for hardwire (common wire) Battery power from 2 AA 1.5v batteries
Operating ambient	20°F to +105°F (0°C to +41°C)
Operating humidity	90% non-condensing maximum
Dimensions of thermostat	4.7"W x 4.4"H x 1.1"D

Contact Us

Pro1 IAQ Inc.

1111 S. Glenstone
Suite 2-100
Springfield, MO 65804

Toll-free: 1-888-Pro1iaq (776-1427)

Toll Number (Outside the USA): 330-821-3600

Web: <http://www.pro1iaq.com>

Hours of Operation: Monday - Friday 9 AM - 6 PM Eastern