



TJERNLUND PRODUCTS, INC.

1601 Ninth Street • White Bear Lake, MN 55110-6794
PHONE (800) 255-4208 • (651) 426-2993 • FAX (651) 426-9547
Visit our web site • www.tjernlund.com



AIRESHARE™ ROOM-TO-ROOM VENTILATOR MODEL AS1

READ OWNERS INSTRUCTIONS CAREFULLY PRIOR TO INSTALLATION. THESE INSTRUCTIONS MUST REMAIN WITH EQUIPMENT. DO NOT DESTROY.



DESCRIPTION

The Tjernlund AireShare™ Room-to-Room Ventilators distribute air from one conditioned space to another. Virtually, every home has a room that is uncomfortably hot or cold from which some of that room's air can be shared with an adjacent room, making the temperature of both rooms more comfortable. The AireShare transfers air through the wall cavity created between two wall studs, making the temperature of both rooms more comfortable. The AireShare's unique option of moving the air up or down within the wall cavity allows for optimum heat transfer between rooms – a typical application will change the temperature 3 °F per hour. In addition, locating the grill and diffuser, one high the other low, prevents the transfer of light and sound between these adjacent rooms.

SPECIFICATIONS & COMPONENTS

MODEL AS1

Blower: 75 cfm
Motor: 115 Volts ~ 60 Hz
0.50 amps maximum
Impeller: Transtangential, cross-flow
Dimensions:
Diffuser: 14 5/8" X 2 1/4" (flush)
Grill: 15 3/4" X 7 3/4" (flush)
Color: Neutral White



GENERAL INFORMATION

Every Tjernlund AireShare™ Room-to-Room Ventilator is electrically factory line tested before shipment.

After opening carton, inspect thoroughly for shipping damage. Impeller should rotate freely and all electrical wires and connections should be secured. If any damage is found, notify freight carrier and your distributor immediately and file a concealed damage claim.

INSTALLATION RESTRICTIONS

The AireShare™ Ventilator must be installed by a qualified installer in accordance with these instructions and all local codes or in their absence in accordance with the latest editions of the International Residential Code and International Electrical Code. Improper installation can create a hazardous condition such as fire, electric shock or personal injury. To reduce these risks significantly, use this device only in the manner intended by the manufacturer. If you have questions about proper usage of this device, call Tjernlund Products.

Always disconnect the AireShare™ Ventilator from its power source before installation and servicing.

IMPORTANT: An in depth investigation of the wall layout is required prior to installation. Avoid a stud wall section that is a path for plumbing supply lines, drains and vents. Avoid a stud wall section that is insulated or being used as a return air duct for a forced air system. If stud walls are constructed with metal studs the Diffuser must be mounted 3" above the Blower opening since metal studs typically are not solid throughout.

▲ WARNING

- The AireShare™ may not be used to exhaust hazardous or explosive materials or vapors.
- The AireShare™ may not be installed in a ceiling.
- The AireShare™ may not be installed in an outside wall.
- The AireShare™ may not be installed in a wall rated as a “fire wall.”
- The AireShare™ may not be used to move air from one floor (story) to another floor.
- The AireShare™ may not be used to move moisture-laden air from sources such as bathrooms and kitchens.
- The AireShare™ may not be used in a window.

WARNING: To reduce the risk of fire, electrical shock and injury to persons, the AireShare™ must be installed with the AS1 Diffuser that was provided with the AS1. Do not use this product without the AS1 Diffuser or with any Diffuser other than the AS1 Diffuser.

WARNING: To reduce the risk of fire or electrical shock, do not use this fan with any solid state speed control devices.

▲ WARNING

Disrupt power at circuit breaker to outlets within the stud wall you will be working.

When sawing through sheetrock you must stop if you detect the saw blade coming in contact with any wiring or plumbing. Investigate further to determine if possible to safely still use this wall cavity space. Switch to another stud wall cavity if necessary.

BEFORE YOU START:

Determine the stud wall section that you want to use to mount the Blower and Diffuser. It may be preferable to select a stud wall section that contains an electrical outlet for wiring. **IMPORTANT: Wall studs must be spaced a minimum of 16” o.c., (See Diagram A).** Mark inside edges of studs the AireShare will be installed between and verify there is at least 14” between the inside edges. Slide a stud finder down the wall between the studs to verify the stud wall cavity is completely open, (See Diagram B).

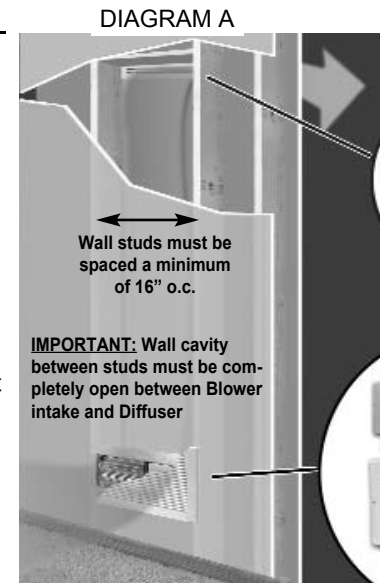

TOOLS REQUIRED

Sheetrock Saw Philips & Straight Screwdrivers Level Tape Measure Utility Knife or Scissors Wire Stripper

INSTALLING DISCHARGE DIFFUSER

IMPORTANT: Install Diffuser first if mounting the Blower down low and the Diffuser high so sheetrock from the Diffuser cut out does not fall into wall cavity and damage Blower. Install the Blower first if mounting the Blower high and Diffuser low so sheetrock from the Blower cut out does not fall into wall cavity and damage Diffuser.

NOTE: Typical installations will have the Diffuser high and the Blower low, but there may be instances where it is desirable to have the Blower mounted high and the Diffuser low to take air from the ceiling level.

1. Determine if you would like a high or low discharge. The diffuser may be mounted as close as 3” above the top of Blower cut out opening or as close as 3” to the ceiling.
2. Level and mark a line between studs where you want the top of the Diffuser, (See Diagram C)
3. Using a hand sheetrock saw carefully make a horizontal cut along the line. Cut the sheetrock completely until you come in contact with the opposite stud. **NOTE:** If studs are spaced greater than 16” o.c., the horizontal cut line should not exceed 14”, (See Diagram D).

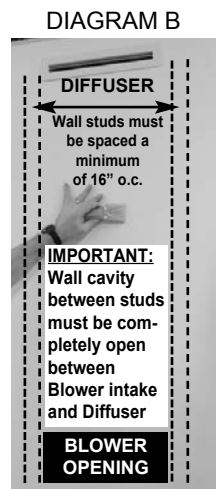
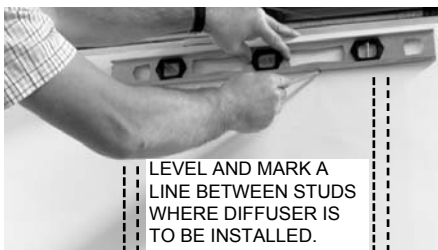
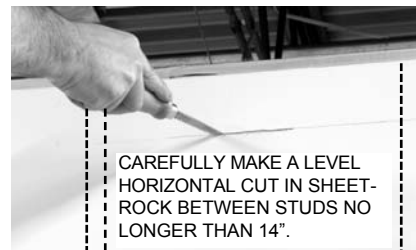

DIAGRAM C



LEVEL AND MARK A LINE BETWEEN STUDS WHERE DIFFUSER IS TO BE INSTALLED.

DIAGRAM D



CAREFULLY MAKE A LEVEL HORIZONTAL CUT IN SHEETROCK BETWEEN STUDS NO LONGER THAN 14”.

- Cut out diffuser template on dashed lines. Align the top of template with the wall cut and center it so that there is an equal space between the right and left edges of the template and ends of the cut in the sheetrock. Mark all 4 corners of template, connect with a straight edge and cut Diffuser opening in wall (**Diffuser opening should be 1 1/4" high x 13 5/8" wide**), (See Diagram E).
- Insert diffuser with the air scoop on the back pointing towards the blower. Adjust tangs on the sides if necessary to secure a tight fit into the wall opening, (See Diagram F).

DIAGRAM E

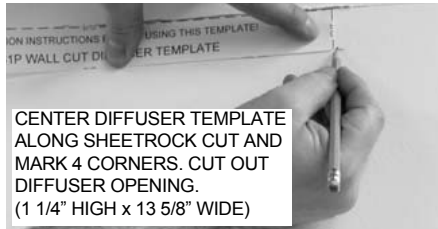
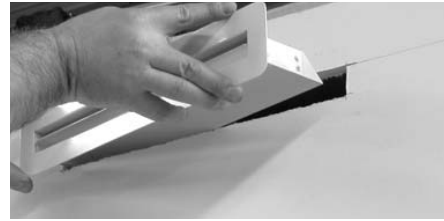

DIAGRAM F



BLOWER INSTALLATION

IMPORTANT: Install Diffuser first if mounting the Blower down low and the Diffuser high so sheetrock from the Diffuser cut out does not fall into wall cavity and damage Blower. Install the Blower first if mounting the Blower high and Diffuser low so sheetrock from the Blower cut out does not fall into wall cavity and damage Diffuser.

NOTE: Typical installations will have the Diffuser high and the Blower low, but there may be instances where it is desirable to have the Blower mounted high and the Diffuser low to take air from the ceiling level.

- If installing in a stud wall section with an electrical outlet, place Blower intake grill in desired position on stud wall verifying that the bottom edge is above floor molding and that the top edge is below the bottom of any electrical outlet cover. Level top edge and mark wall through the two mounting holes. **NOTE:** This is assuming the Blower is mounted down low and the Diffuser high.. (See Diagram G). If installing the Blower up high and the Diffuser low, the top of the Blower intake grill must be mounted at least 2" below the ceiling.
- Use a level to draw a vertical plumb line up 2 7/16" inches from each marked hole. Connect the top of the lines using a straight edge, (See Diagram H).
- Using a hand sheet rock saw carefully make a horizontal cut along the line going away from outlet. Cut the sheetrock completely until you come in contact with the opposite stud . **NOTE:** If studs are spaced greater than 16" o.c., the horizontal cut line should not exceed 14 1/2", (See Diagram I).

DIAGRAM G



DIAGRAM H

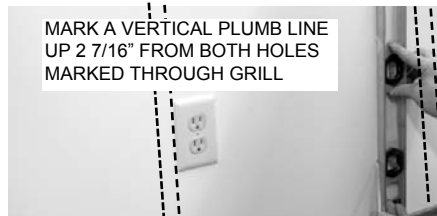

DIAGRAM I



- Align the top of AS1 Blower template with the wall cut and center it so that there is an equal space between the right and left edges of the template and ends of the cut in the sheetrock. Mark all 4 corners of template, connect with a straight edge and cut rectangular opening in wall (**Model AS1 Blower opening should be 4 7/8" high x 13 7/8" wide**), (See Diagram J).
- Provide a switched 120 VAC power source with leads long enough to connect to the motor leads of the AireShare while it is positioned just outside Blower opening cut in sheetrock, (See Diagram K).
- Carefully insert the Blower into the cutout. Level the top flange and mark the larger Blower flange mounting holes. Using the provided wood screws, secure the blower to the wall studs. Use provided wall anchors if not installing into studs, (See Diagram L).

DIAGRAM J

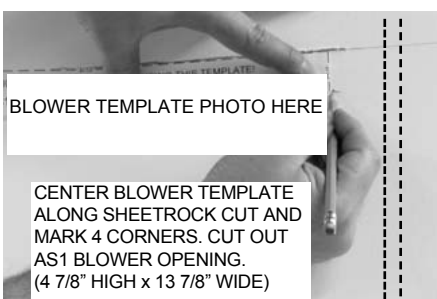

DIAGRAM K



DIAGRAM L



WIRING

▲ WARNING

Disrupt power at circuit breaker to outlets within the stud wall you will be working.

1. Wire Blower into switched 120 VAC power source as shown below.

AIRESHARE™ MODEL AS1 WIRING CONNECTIONS

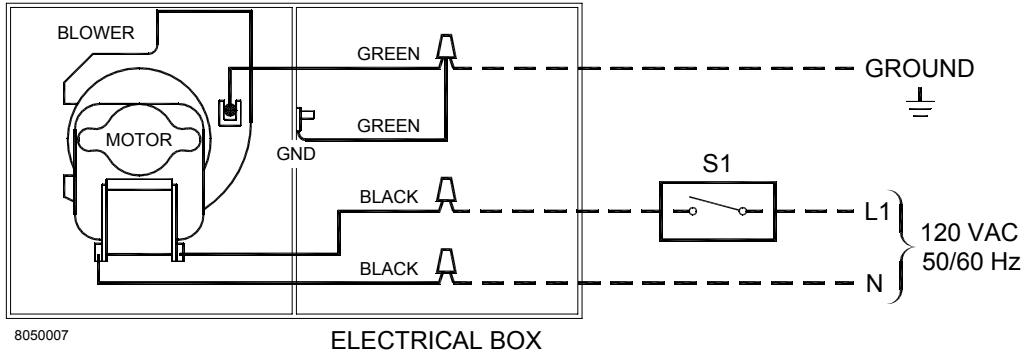

- ▲ = WIRE NUTS SUPPLIED BY OTHERS
 - - - = WIRING SUPPLIED BY OTHERS
 S1 = SWITCH SUPPLIED BY OTHERS (120 VAC T-STAT, WALL SWITCH, ETC.)

2. Attach Blower electrical box coverplate, (See Diagram M).

3. Attach Intake Grill to Blower with provided screws. **NOTE:** If Blower is installed up high towards the ceiling, grill should be installed with vanes pointing up so Blower can not be seen, (See Diagram N).

DIAGRAM M



DIAGRAM N



MAINTENANCE

The AireShare Blower wheel should be inspected annually and carefully cleaned or vacuumed with a bristle brush head if necessary. The motor is permanently lubricated and requires no maintenance.

REPLACEMENT PARTS AND WARRANTY

Component	Part Number	Component	Part Number
AS1 Intake Grill	950-3300	AS1/AS1P Blower Assembly	950-3303
AS1/AS1P Diffuser	950-3302		

TJERNLUND LIMITED ONE YEAR WARRANTY

Tjernlund Products, Inc. warrants to the original purchaser of this product that the product will be free from defects due to faulty material or workmanship for a period of (1) year from the date of original purchase or delivery to the original purchaser, whichever is earlier. Remedies under this warranty are limited to repairing or replacing, at our option, any product which shall, within the above stated warranty period, be returned to Tjernlund Products, Inc. at the address listed below, postage prepaid. THERE ARE NO WARRANTIES WHICH EXTEND BEYOND THE DESCRIPTION ON THE FACE HEREOF, AND TJERNLUND PRODUCTS, INC. EXPRESSLY DISCLAIMS LIABILITY FOR INCIDENTAL OR CONSEQUENTIAL DAMAGES ARISING FROM THE USE OF THIS PRODUCT. THIS WARRANTY IS IN LIEU OF ALL OTHER EXPRESS WARRANTIES AND NO AGENT IS AUTHORIZED TO ASSUME FOR US ANY LIABILITY ADDITIONAL TO THOSE SET FORTH IN THIS LIMITED WARRANTY. IMPLIED WARRANTIES ARE LIMITED TO THE STATED DURATION OF THIS LIMITED WARRANTY. Some states do not allow limitation on how long an implied warranty lasts, so that limitation may not apply to you. In addition, some states do not allow the exclusion or limitation of incidental or consequential damages, so that above limitation or exclusion may not apply to you. This warranty gives you specific legal rights and you may also have other rights which may vary from State to State. Send all inquiries regarding warranty work to Tjernlund Products, Inc. 1601 9th Street, White Bear Lake, MN 55110-6794. Phone (651) 426-2993 • (800) 255-4208 • Fax (651) 426-9547 • Email fanmail@tjfans.com.