

VENSTAR®

DIGITAL THERMOSTAT



RESIDENTIAL WIRELESS THERMOSTAT T1100RF

7-DAY PROGRAMMABLE UP TO 2-HEAT & 2-COOL



- Control up to 2 Heat & 2 Cool Stages
- Full Range of Compatibility for Use on Gas/Electric, HP, Electric and Hydronic Heat
- 7-Day Programmable
- 4 Settings/Day
- Auto Changeover
- 5 minute Built-In Compressor Protection
- Self-Prompting Programming w/ Copy
- Full Electronic
- Display Either F or C
- Back-Lit Display
- Keypad Lockout
- Large Easy-to-Read Display
- Programmable Fan

- Dual Setpoint w/ Adjustable Deadband
- 'O' or 'B' Terminal
- Optional Power Supply (ACC0800)

Unique Features

- Non-Volatile Memory
- Wireless: Transmits up to 500 feet, through walls and floors - 418 MHZ will not interfere with other systems
- Receiver capable of listening to up to 4 thermostats
- Thermostat capable of transmitting to multiple receivers

Applications

- No wires to run
- Ideal for century old homes
- Ideal for keeping the baby's room the perfect temperature

- Use with most Air Conditioning & Heating Systems including: 1 or 2 Stage Electric Cooling & 2 Stage Gas Heating, Heat Pump, Electric or Hydronic Heat.



OWNER'S MANUAL

© Venstar Inc. 08/07

Table Of Contents

FRONT PANEL	2
DISPLAY	3
QUICK START <i>Set the clock and go</i>	5
SELECTING THE HEAT OR COOL MODE	6
BASIC OPERATION	7
PROGRAMMING A DAILY SCHEDULE	8
ADVANCED SETUP	12
ABOUT ADVANCED FEATURES & OPERATION	16
WARRANTY	20

CAUTION Follow *Installation Instructions* carefully.



DISCONNECT POWER TO THE HEATER -
AIR CONDITIONER BEFORE REMOVING
THE OLD THERMOSTAT AND INSTALLING
THE NEW THERMOSTAT.



WARNING

This device complies with Part 15 of the FCC Rules. Operation is subject to the following two conditions: (1) this device may not cause harmful interference, and (2) this device must accept any interference received, including interference that may cause undesired operation.



P/N T1100RF

© Venstar Inc. 08/07

Front Panel

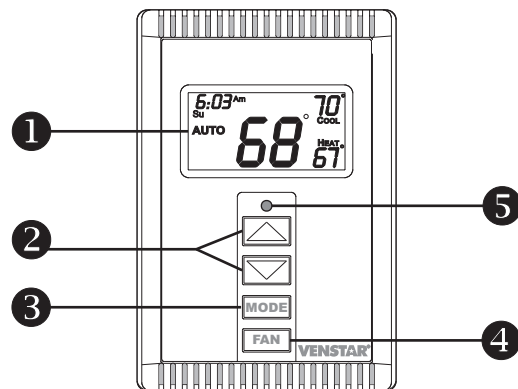

- 1** Liquid Crystal Display
with Thermoglow™
- 2** Up/Down Buttons
- 3** Mode Button
- 4** Fan Button
- 5** Transmission Indicator
Blinking Green = Communicating
with the Receiver

Display

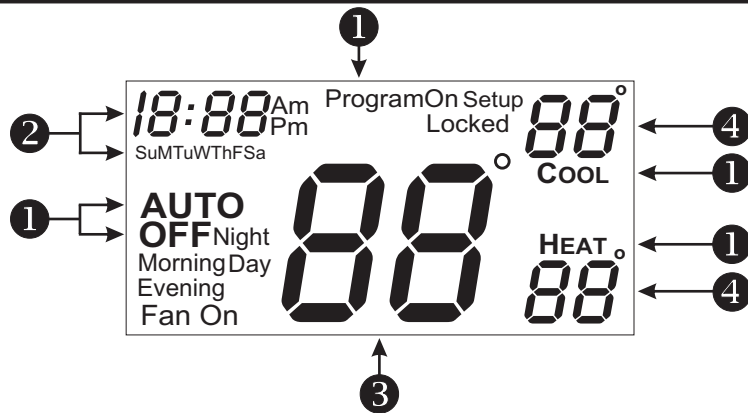

- 1** Mode Indicators - *Page 6*
 Selects the operational mode of the equipment.
HEAT - Indicates the heating mode.
COOL - Indicates the air conditioning mode.
AUTO - Indicates the system will automatically changeover between heat and cool modes as the temperature varies.
PROGRAM ON - Indicates the time period program is enabled to run.
OFF - Indicates heating and cooling are turned off.
- 2** Clock with Day of the Week - *Page 5*
 Indicates the current time and day. This clock is also used to program the time period schedules.
- 3** Room Temperature Display
 Indicates current room temperature.
- 4** Desired Set Temperature - *Page 7*
 Indicates desired room temperature(s).

Display

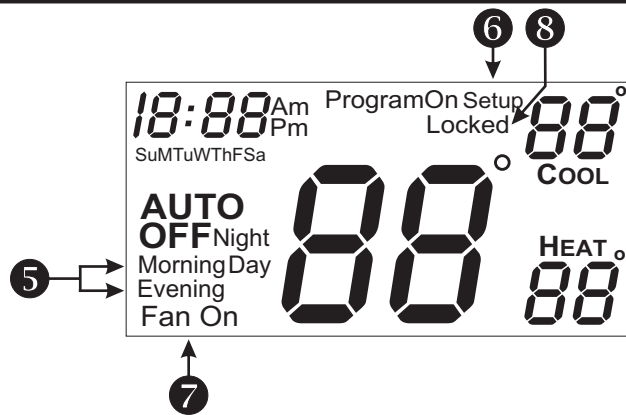

- 5** **Morning, Day, Evening & Night** icons - *Pages 8-10*
Indicates the day part of the time period program.
- 6** **Setup** icon - *Pages 12-14*
Indicates the thermostat is in the setup mode.
- 7** **Fan On** icon - *Page 7*
Indicates constant, continuous fan operation.
When **Fan On** is not lit - indicates the fan will only operate when necessary to heat or cool.
- 8** **Locked** icon - *Page 18*
Indicates the keypad has been locked.

Quick Start *Set the Clock and Go*



Press the **MODE** button.
While holding **MODE**,
press the **FAN** button for
two seconds to enter Setup
screens.

During Setup & Programming:

*Pressing the UP or DOWN
button will modify the
flashing selection.*

Setting the Clock

*Tip: To change hours
quickly, press and
hold the FAN button,
then press the UP or
DOWN button.*



To adjust the
Clock or Day use



buttons.

Setting the Day



Press
MODE

Press the **MODE** button.
While holding **MODE**,
press the **FAN** button for
two seconds to enter Setup
screens.



The thermostat is preprogrammed from the factory to operate one or two stage equipment* without the need for further programming. To optimize the installation of this thermostat, follow the instructions in the Advanced Setup section.

** The thermostat is not preprogrammed from the factory to operate electric heat or heat pump systems. To control these systems, follow the instructions in the Receiver manual.*

Selecting the Heat or Cool Mode

Select Mode by Pressing the MODE Button

Heating Only

The **HEAT** setting indicates the temperature the room has to reach before the furnace will turn on to heat the room.



Cooling Only

The **COOL** setting indicates the temperature the room has to reach before the air conditioner will turn on to cool the room.



Heating or Cooling

AUTO will automatically select heat or cool based on room temperature demand.



Time Schedule for Heating or Cooling

The **Program On** setting will activate the time period programming for the cooling or heating setpoint ONLY (Morning, Day, Evening & Night Periods).

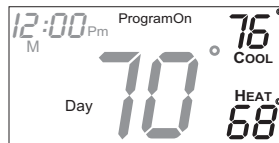

Off

OFF indicates both heating and air conditioning systems are turned off.



Basic Operation

Selecting Your Desired Temperature (adjusting the setpoints)

AUTO OR PROGRAM MODE

Pressing the UP or DOWN button in Auto **or** Program mode will adjust **both** the heat and cool set temperatures simultaneously.



Adjust the desired set temperature with the



buttons.

HEAT OR COOL MODE

Pressing the UP or DOWN button in Heat **or** Cool mode will adjust only the heat **or** cool set temperature.



Adjust the desired set temperature with the



buttons.

Using the Fan Button



Press



Fan On indicates constant fan operation. You may turn the fan on even if the thermostat is in the **Off** mode. Pressing the FAN button toggles this feature on or off.

Note: If the backlight is set to OFF, any button press will turn on the backlight for 8 seconds. To change a setting, you must immediately press the button again.

Programming a Daily Schedule

(Unit # 1 only)



MODE

Press the **MODE** button. While holding **MODE**, press the **UP** button for two seconds to enter time period programming.*

Use the Programming Worksheet on the back cover to help with this section.



Select the day of week.
(M - Su)



Press

MODE



Adjust the start time for Morning.



Press

MODE



Adjust the cooling setpoint for Morning.
(35° - 99°)

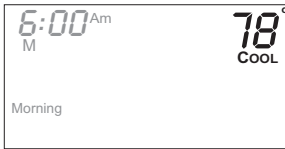

Press

MODE



Adjust the heating setpoint for Morning.
(35° - 99°)



Press

MODE

*Time period programming is only available on Unit Number 1.

Continued

Programming a Daily Schedule

(Unit # 1 only)

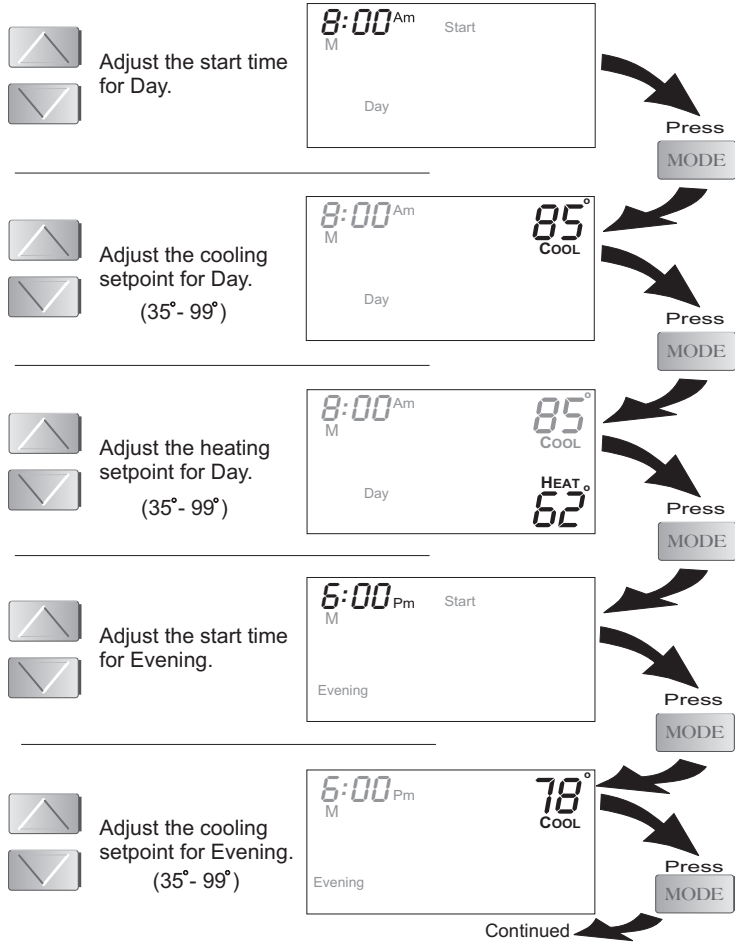

Programming a Daily Schedule

(Unit # 1 only)



Adjust the heating setpoint for Evening.
(35° - 99°)

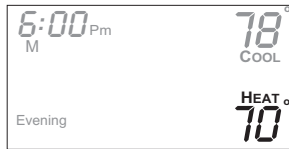

Press

MODE



Adjust the start time for Night.

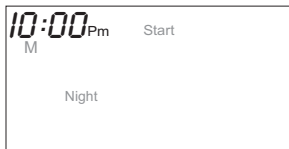

Press

MODE



Adjust the cooling setpoint for Night.
(35° - 99°)

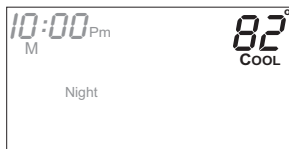

Press

MODE



Adjust the heating setpoint for Night.
(35° - 99°)

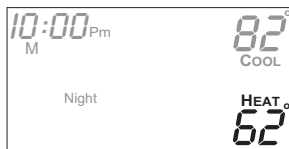

Press

MODE

Continued

Programming a Daily Schedule

(Unit # 1 only)

The copy command becomes available after programming the entire previous day.

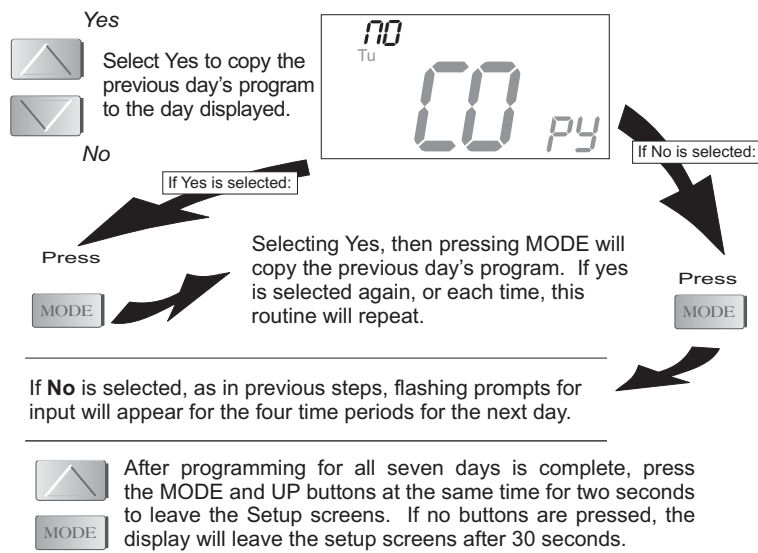

Advanced Setup



Press the **MODE** button and release.



Immediately press the **MODE** button again. While holding the **MODE** button, press the **FAN** button. When this screen appears



DO NOT RELEASE THE BUTTONS.

Continue holding the **MODE** and **FAN** buttons for an additional seven seconds to enter Setup screens beyond step #2.

NOTE: Each step # is located at the top right corner of the display for easy reference.



Adjust the time of day clock.



*Tip: To change hours quickly, press and hold the **FAN** button, then press the **UP** or **DOWN** button.*

Press



Select the day of the week.



Press



Yes
Leave this setup step set to NO.

No





Press





Continued

Advanced Setup

-  Select the House Code number. *The Receiver must also use this same number for proper operation.*
-  (0 - 63)



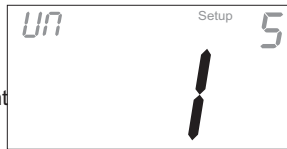

Press
MODE

-  Select the Unit ID number. If more than 1 thermostat is used, each will need a different Unit ID number.
-  (1 - 4)





Press
MODE

-  Adjust the deadband for the 1st stage.
-  (1° - 6°)

Note: Available only on Unit ID #1.





Press
MODE

-  Adjust the minimum **difference** between cooling & heating setpoints.
-  (0° - 6°)



Press
MODE

-  Select the cycles per hour limit:
-  d=cycles per hour limit defeated
-  d1=d + defeat 5 min. compressor lockout
- (d1, d, 2 - 6)

Note: Available only on Unit ID #1.



Press
MODE

Advanced Setup

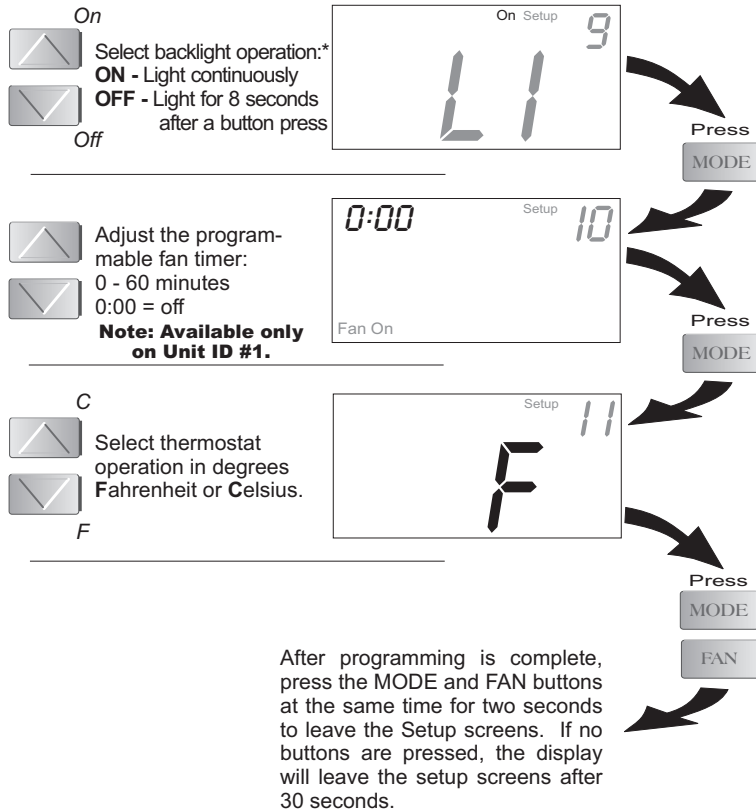

**For increased battery life the backlight should be set to OFF unless the ACC0800 RF power supply adaptor is used to power the thermostat.*

Advanced Setup

Advanced Setup Table

Step #	Description	Range	Factory Default
1	Time of Day	24 hour	12:00 am
2	Day of the Week	M - Su	M
3*	Zoning System	Yes / No	No
4	House Code	0 - 63	0
5	Unit ID Number	1 - 4	1
6**	Deadband/Temp. Swing 1st Stage	1° - 6°	2°
7	Minimum Heat/Cool Differential	0° - 6°	2°
8**	Cycles Per Hour	d, d1, 2 - 6	6
9***	Thermoglow Backlight	Off / On	On
10**	Programmable Fan	0:00 - 0:60	0:00
11	Fahrenheit or Celsius	F / C	F

*For proper operation this setup step should remain in the "No" position.

**These setup steps are only available on the thermostat programmed as Unit ID Number 1.

***For increased battery life the backlight should be set to OFF unless the ACC0800 RF power supply adaptor is used to power the thermostat.

About Advanced Features & Operation

- * CALIBRATION - Under normal circumstances it will not be necessary to adjust the calibration of the temperature sensor. If calibration is required, please contact a trained HVAC technician to correctly perform the following procedure.

- 1** Press **MODE** Place the thermostat in the OFF mode.

- 2** Press and hold the **MODE** button. While holding the **MODE** button, press and hold the **DOWN** button for 5 seconds. All of the icons will appear on the display.

- 3** Press the **MODE** button **twice**. The thermostat temperature will be displayed and may be calibrated using the UP or DOWN buttons

- 4** After calibration is complete, press the **MODE** button **once** to save your changes and return to normal operation.



- * DEADBAND OPERATION - Controls up to two Heat and two Cool stages (please see the diagram below).

The **1st Stage** of heat or cool is turned on when:

- (A) The temperature spread from the setpoint is equal to or greater than: *the setpoint plus the 1st stage deadband (step #6, page 13)*. This 1st stage deadband is adjustable from 1-6 degrees and the default is two degrees.

The **2nd Stage** of heat or cool is turned on when:

- (A) The 1st Stage has been on for a minimum of *two minutes*.

And

- (B) The temperature spread from the setpoint is equal to or greater than: *the setpoint plus the 1st stage deadband (step #6, page 13), plus the 2nd stage deadband*. This 2nd stage deadband is fixed at two degrees and is not adjustable.

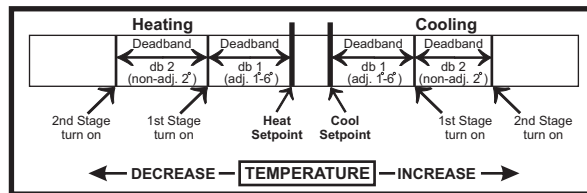



About Advanced Features & Operation

- * **FACTORY DEFAULTS** - If, for any reason, you desire to return all the stored settings back to the factory default settings, follow the instructions below.

WARNING: This will reset all Time Period and Advanced Programming to the default settings. Any information entered prior to this reset will be permanently lost.

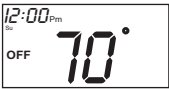
- 1** Place the thermostat in the OFF mode.

- 2** Press and hold the MODE button. While holding the MODE button, press and hold the DOWN button for 5 seconds. All of the icons will appear on the display.

- 3** After all of the icons appear, release the MODE and DOWN buttons. Then press and hold the FAN button for 5 seconds.

- 4** After the letters Fd appear on the display (Factory Default), release the FAN button. Press the MODE button **twice** to return to normal operation. Two dashes will appear momentarily as the display resets.



- * **HEAT/COOL DIFFERENTIAL** - The Heat and Cool setpoints will not be allowed to come any closer to each other than the value set in Advanced Setup *step #7, on page 13*. This minimum difference is enforced during Auto-changeover and Program On operation.

Note: To increase the spread between the heating and cooling setpoints, press the MODE button until only the heat setpoint is displayed; adjust to the desired setpoint. Press the MODE button until only the cool setpoint is displayed; adjust to the desired setpoint. Press the MODE button again to enter the Auto-changeover mode where both the heat and cool setpoints are displayed.

- * **MEMORY BACKUP** - In the event of a power loss, the thermostat will retain the stored program settings without external power or batteries.
- * **PROGRAMMABLE FAN** - This timer will start the fan at the top of each hour; and the fan will run for the number of minutes selected in step #10 on page 14.

About Advanced Features & Operation

- * **KEYPAD LOCKOUT** - To prevent unauthorized use of the thermostat, the front panel buttons may be disabled. To disable, or 'lock' the keypad, press and hold the MODE button. While holding the MODE button, press the UP and DOWN buttons together. The LOCKED icon will appear on the display, then release the buttons.

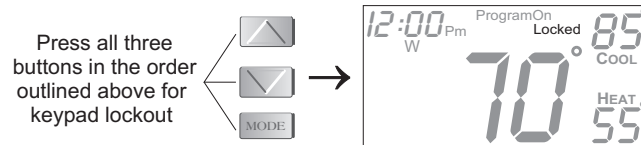

To **unlock** the keypad, press and hold the MODE button. While holding the MODE button, press the UP and DOWN buttons together. The LOCKED icon will disappear from the display, then release the buttons.

- * **BATTERY ELIMINATOR** (optional accessory) - the ACC0800 RF power supply adaptor is used to power the thermostat and eliminate the need for replacing batteries each year. Use only the Venstar accessory ACC0800 for proper operation.
- * **LOW BATTERY WARNING** - The two AA lithium batteries must be replaced at least once every 12 months to ensure proper operation. The "low battery" icon (fig. 1) will appear on the display when it is time to replace the batteries.

When the "low battery" icon is displayed the batteries must be replaced immediately (see next page). The manufacturer cannot be liable for improper operation of the thermostat if the batteries are not immediately replaced. Annual battery replacement is especially critical in locations subject to freezing temperatures. The thermostat will be unable to turn on the heating system if the batteries are exhausted.

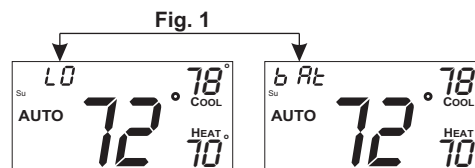

Important: To ensure proper operation use only AA LITHIUM batteries.

About Advanced Features & Operation

* BATTERY REPLACEMENT - To replace the batteries:

- 1 Separate the thermostat from the backplate by pulling the top of the backplate with one hand while pulling on the top corner of the thermostat with your other hand.
- 2 Then turn the thermostat over to remove the batteries from the holder and replace with AA Lithium batteries. You may experience improper operation with the use of alkaline batteries.

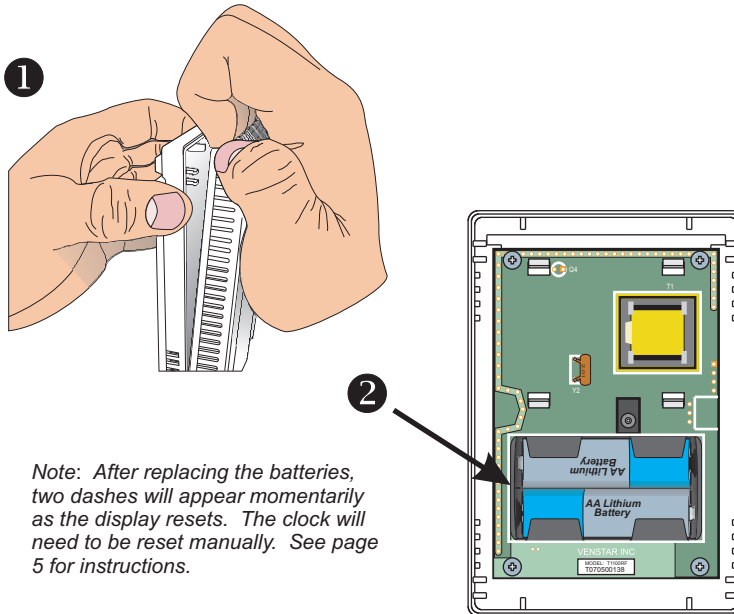

Note: After replacing the batteries, two dashes will appear momentarily as the display resets. The clock will need to be reset manually. See page 5 for instructions.

Important: To ensure proper operation use only AA LITHIUM batteries.

Warranty

One-Year Warranty - This Product is warranted to be free from defects in material and workmanship. If it appears within one year from the date of original installation, whether or not actual use begins on that date, that the product does not meet this warranty, a new or remanufactured part, at the manufacturer's sole option to replace any defective part, will be provided without charge for the part itself provided the defective part is returned to the distributor through a qualified servicing dealer.

THIS WARRANTY DOES NOT INCLUDE LABOR OR OTHER COSTS incurred for diagnosing, repairing, removing, installing, shipping, servicing or handling of either defective parts or replacement parts. Such costs may be covered by a separate warranty provided by the installer.

THIS WARRANTY APPLIES ONLY TO PRODUCTS IN THEIR ORIGINAL INSTALLATION LOCATION AND BECOMES VOID UPON REINSTALLATION.

LIMITATIONS OF WARRANTIES—ALL IMPLIED WARRANTIES (INCLUDING IMPLIED WARRANTIES OF FITNESS FOR A PARTICULAR PURPOSE AND MERCHANTABILITY) ARE HEREBY LIMITED IN DURATION TO THE PERIOD FOR WHICH THE LIMITED WARRANTY IS GIVEN. SOME STATES DO NOT ALLOW LIMITATIONS ON HOW LONG AN IMPLIED WARRANTY LASTS, SO THE ABOVE MAY NOT APPLY TO YOU. THE EXPRESSED WARRANTIES MADE IN THIS WARRANTY ARE EXCLUSIVE AND MAY NOT BE ALTERED, ENLARGED, OR CHANGED BY ANY DISTRIBUTOR, DEALER, OR OTHER PERSON WHATSOEVER. ALL WORK UNDER THE TERMS OF THIS WARRANTY SHALL BE PERFORMED DURING NORMAL WORKING HOURS. ALL REPLACEMENT PARTS, WHETHER NEW OR REMANUFACTURED, ASSUME AS THEIR WARRANTY PERIOD ONLY THE REMAINING TIME PERIOD OF THIS WARRANTY.

THE MANUFACTURER WILL NOT BE RESPONSIBLE FOR:

1. Normal maintenance as outlined in the installation and servicing instructions or owner's manual, including filter cleaning and/or replacement and lubrication.
2. Damage or repairs required as a consequence of faulty installation, misapplication, abuse, improper servicing, unauthorized alteration or improper operation.
3. Failure to start due to voltage conditions, blown fuses, open circuit breakers or other damages due to the inadequacy or interruption of electrical service.
4. Damage as a result of floods, winds, fires, lightning, accidents, corrosive environments or other conditions beyond the control of the Manufacturer.
5. Parts not supplied or designated by the Manufacturer, or damages resulting from their use.
6. Manufacturer products installed outside the continental U.S.A., Alaska, Hawaii, and Canada.
7. Electricity or fuel costs or increases in electricity or fuel costs for any reason whatsoever including additional or unusual use of supplemental electric heat.
8. ANY SPECIAL INDIRECT OR CONSEQUENTIAL PROPERTY OR COMMERCIAL DAMAGE OF ANY NATURE WHATSOEVER. Some states do not allow the exclusion of incidental or consequential damages, so the above may not apply to you.

This warranty gives you specific legal rights and you may also have other rights which may vary from state to state.

Programming Worksheet

see page 8

DAY	PERIOD	START TIME	COOL	HEAT
M O N D A Y	Morning			
	Day			
	Evening			
	Night			
T U E S D A Y	Morning			<i>Copy Mon → Tue</i>
	Day			<input type="checkbox"/> No
	Evening			<input type="checkbox"/> Yes
	Night			
W E D N E S D A Y	Morning			<i>Copy Tue → Wed</i>
	Day			<input type="checkbox"/> No
	Evening			<input type="checkbox"/> Yes
	Night			
T H U R S D A Y	Morning			<i>Copy Wed → Thu</i>
	Day			<input type="checkbox"/> No
	Evening			<input type="checkbox"/> Yes
	Night			
F R I D A Y	Morning			<i>Copy Thu → Fri</i>
	Day			<input type="checkbox"/> No
	Evening			<input type="checkbox"/> Yes
	Night			
S A T U R D A Y	Morning			<i>Copy Fri → Sat</i>
	Day			<input type="checkbox"/> No
	Evening			<input type="checkbox"/> Yes
	Night			
S U N D A Y	Morning			<i>Copy Sat → Sun</i>
	Day			<input type="checkbox"/> No
	Evening			<input type="checkbox"/> Yes
	Night			



Printed on recycled paper.
P/N 88-616 Rev. 3