

VENSTAR®

FAN COIL THERMOSTAT

FAN COIL
THERMOSTAT

T1070



NON- PROGRAMMABLE

2 OR 4 PIPE SYSTEMS

- Remote sensor ready
- 3 speed fan control
- Self-prompting adjustment
- Auto 2-pipe changeover when used with ACC-SENF C changeover sensor
- Dry contact equipped
- Backlit display
- Works with most fan coil systems - 24vac
- Electric heat ready
- Non-volatile memory
- Dual setpoint with adjustable deadband
- Keypad lockout
- Configurable display
- Display F or C

OWNER'S MANUAL AND INSTALLATION INSTRUCTIONS

Table Of Contents

FRONT PANEL	2
DISPLAY	3
SELECTING THE HEAT OR COOL MODE	5
BASIC OPERATION	9
ADVANCED SETUP	10
ADVANCED SETUP TABLE	15
ABOUT ADVANCED FEATURES & OPERATION	16
SAMPLE WIRING DIAGRAMS	25
WARRANTY	29

CAUTION



Disconnect Power
to the Heater/Air Conditioner
before removing the old therm-
ostat and installing the new
thermostat.



WARNING

Model T1070

© Copyright 2012 Venstar, Inc
All Rights Reserved

Front Panel

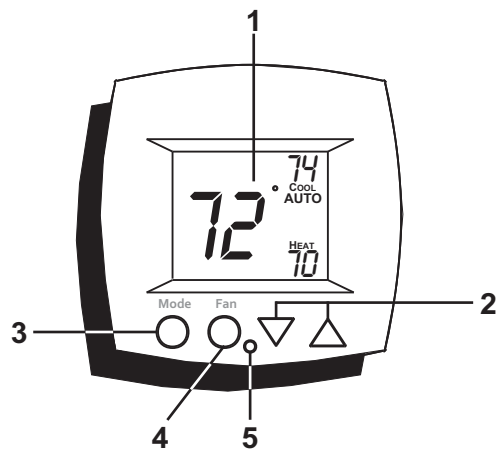

- 1 Liquid Crystal Display
- 2 Up/Down Buttons
- 3 Mode Button
- 4 Fan Button
- 5 Heat or Cool Indicator
Heat = Red, Cool = Green

Display

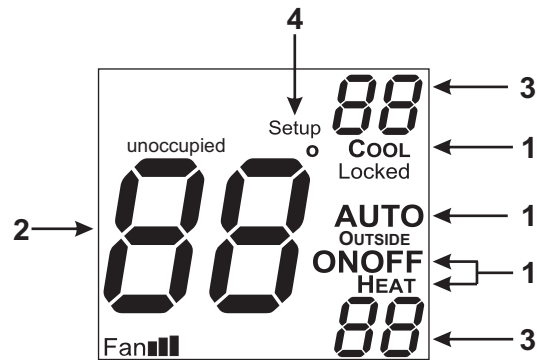

- 1 Mode Indicators - *Page 5-8*
 Selects the operational mode of the equipment.
HEAT - Indicates the heating mode.
COOL - Indicates the cooling mode.
AUTO - Indicates the system will automatically
 changeover between heat and cool modes
 as the temperature varies.
OFF - Indicates heating and cooling are turned off.
- 2 Room Temperature Display
 Indicates current room temperature.
- 3 Desired Set Temperature - *Page 9*
 Indicates desired room temperature(s).
- 4 **Setup** icon - *Pages 10-14*
 Indicates the thermostat is in the advanced setup
 mode.

Display

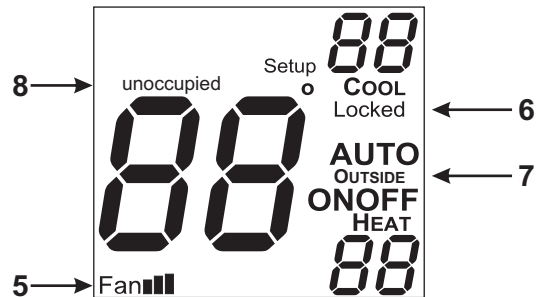

- 5 Fan** icon - *Page 9*
Indicates fan operation.
Fan = low speed
Fan = medium speed
Fan = high speed
When only the **Fan** icon is displayed, the fan is in the Auto mode and will run only when necessary to heat or cool.
- 6 Locked** icon - *Page 21*
Indicates keypad has been locked.
- 7 Outside** icon - *Page 22*
Indicates the temperature displayed is from the optional outside sensor.
- 8 Unoccupied** icons - *Pages 13-14*
Indicates a dry contact forced Unoccupied time period is in effect.

Selecting the Heat or Cool Mode 4-Pipe Operation

Select Mode by Pressing the MODE Button

Heating Only

The **HEAT** setting indicates the temperature the room has to reach before the heating source will turn on to heat the room.

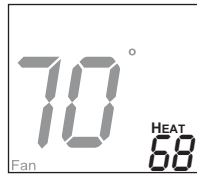

Cooling Only

The **COOL** setting indicates the temperature the room has to reach before the cooling source will turn on to cool the room.

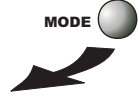

Heating or Cooling
AUTO will automatically select heat or cool based on room temperature demand.

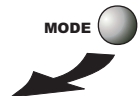
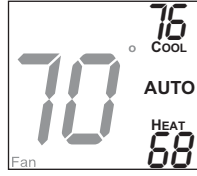

Off

OFF indicates both heating and cooling are turned off.

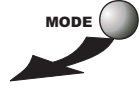

Selecting the Heat or Cool Mode 2-Pipe Operation

Heat Only

Step #4 = 1 in the Advanced Setup section, page 11.

Heating Only

The **HEAT** setting indicates the temperature the room has to reach before the heating source will turn on to heat the room.

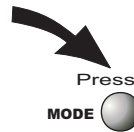
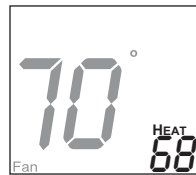

Off

OFF indicates both heating and cooling are turned off.



Selecting the Heat or Cool Mode 2-Pipe Operation

Cool Only

Step #4 = 2 in the Advanced Setup section, page 11.

Cooling Only
The **COOL** setting indicates the temperature the room has to reach before the cooling source will turn on to cool the room.

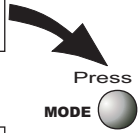

Off
OFF indicates both heating and cooling are turned off.



Selecting the Heat or Cool Mode 2-Pipe Operation

Heating and/or Cooling

Step #4 = 3 in Advanced Setup (page 11), and the accessory changeover sensor (ACC-SENF) is used. If step #4 = 4 or 5 in Advanced Setup (page 11). Operation is the same as a 4-pipe system (page 5).

HEAT indicates the temperature the room has to reach before the heating source energizes. If the water supply is cold, this screen and heating would be locked out.

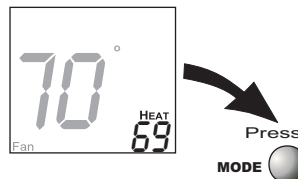

COOL indicates the temperature the room has to reach before the cooling source energizes. If the water supply is hot, this screen and cooling would be locked out.

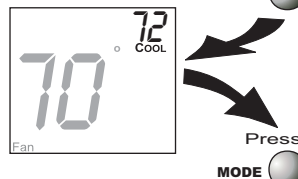

If step #4 = 3, this screen will not appear.

AUTO will automatically select heat or cool based on the room temperature demand.

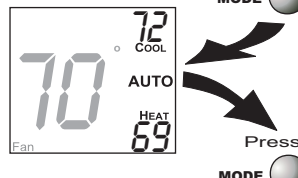

OFF indicates both heating and cooling are turned off.

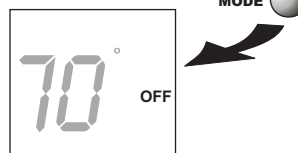

Note: If the water temperature is changed during the year, the thermostat will then automatically lock out the incorrect mode.

Basic Operation

Selecting Your Desired Temperature (adjusting the setpoints)

AUTO OR PROGRAM MODE

Pressing the UP or DOWN button in Auto or Program mode will adjust **both** the heat and cool set temperatures simultaneously.

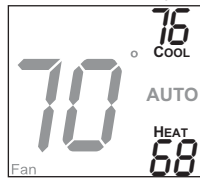

Adjust the desired set temperature with the



buttons.

Fan Operation

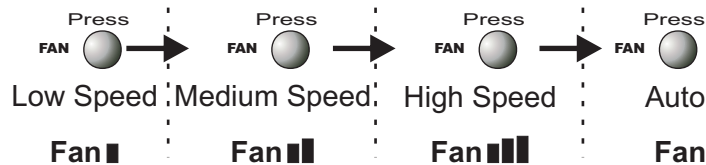
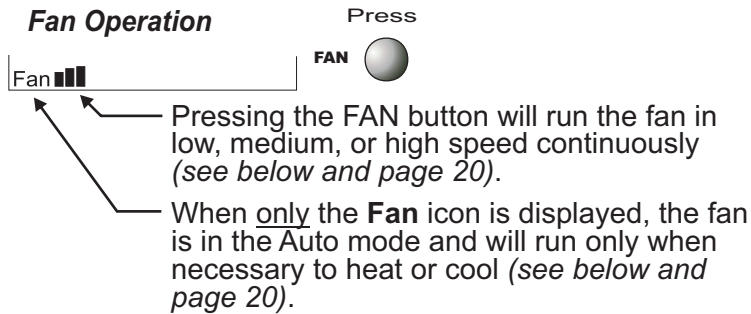

Note: If the thermostat is placed in the Off mode, the fan will de-energize.

Advanced Setup

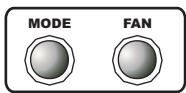

Press the MODE and FAN buttons at the same time for 10 seconds to enter Advanced Setup screens.

NOTE: Each step # is located at the top right corner of the display for easy reference.

Display On



Select Display operation:

On = Full Display



Off = Minimal display

Display Off

See Page 20

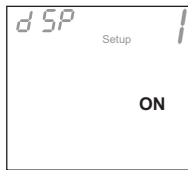

Select Display operation:

1 = Single Setpoint



2 = Dual Setpoint

See Page 24

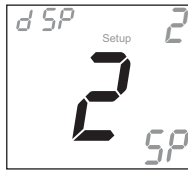

Note: When Single Setpoint is selected, the heating or cooling setpoint will always be displayed. To display the room temperature, press and hold the MODE button for two seconds. The degree icon will blink when the large number is displaying room temperature and will remain solid when displaying the heating or cooling setpoint.

Press



Press



Continued

Advanced Setup

- 4 Select fan coil system type:
 2 = 2-pipe fan coil
 4 = 4-pipe fan coil

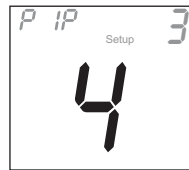

Step #4 only appears if step #3 = 2.

2-PIPE SYSTEM OPERATION

- 1= Heat only system
 2= Cool only system
 3= Heat/Cool Auto changeover
 4= Heat/Cool Aux Electric heat, Lockout Electric Heat when Hot Water is available
 5= Heat/Cool total electric heat, **no** Hot Water, **only** Electric Heat.

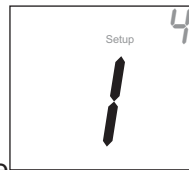

Note: Steps #3 & #4 require accessory changeover sensor ACC-SEFC

- Select operation when fan is in the Auto mode:
 On = continuous low speed fan
 Off = only energize during a heating or cooling cycle.

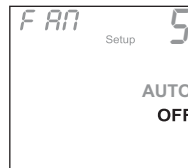

See Page 20, Note #2 for additional information for this step.

Continued

Advanced Setup

Select Fan Coil Type



- On** = Carrier or IEC fan coil using a 33ZCRLYBRD relay board.
Off = Conventional 3 speed fan coil system.

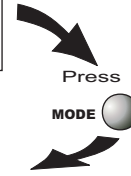

See Page 24 for further explanation of Fan Coil Type.



Adjust the deadband for the 1st stage.
(1° - 6°)

See Page 17

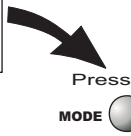
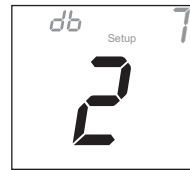

Step #7 will not appear if step #4 = 1 or 2.



Adjust the minimum **difference** between cooling & heating setpoints.
(0° - 6°)

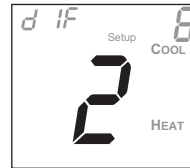

- On** - Light continuously
Off - Light for 8 seconds after a button press



Advanced Setup

C
▲
▼
F

Select thermostat operation in degrees Fahrenheit or Celsius.



Press
MODE

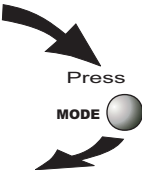

Yes
▲
▼
No

Select sensor operation:
Yes = read only duct sensor
No = control to duct sensor

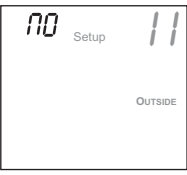

NO
▲
▼
NC

Dry Contact
NO = Normally Open
NC = Normally Closed
See Page 18



Press
MODE

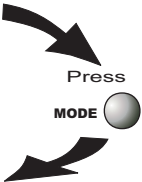

Continued

Advanced Setup

Unoccupied Setpoints



Select Dry Contact
Unoccupied operation:

Unoccupied = when the Dry Contact is closed, the thermostat will control to the Unoccupied setpoints.

Off = when the Dry Contact is closed, the thermostat will be forced into the Off mode.

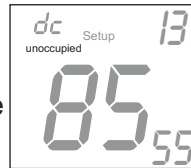

Press
MODE



Adjust the cooling setpoint for unoccupied periods.
(35° - 99°, OF)

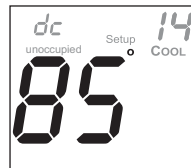

Press
MODE



Adjust the heating setpoint for Unoccupied periods.
(OF, 35° - 99°)

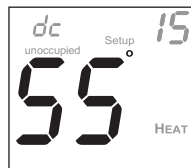

After programming is complete, press the MODE and FAN buttons at the same time to leave the Setup screens. If no buttons are pressed, the display will leave the setup screens after sixty seconds.

Advanced Setup

Advanced Setups - Table



Step	Description	Range	Default
1	Display Declutter	On / Off	On
2	Single or Dual Setpoint	Single / Dual	2
3	2 or 4 Pipe System	2 / 4	4
4	2 Pipe System Operation	5 Choices	1
5	Fan Auto Operation	On / Off	Off
6	Fan Coil Type Operation	On / Off	Off
7	1st Stage Deadband	1 - 6	2
8	Heat Cool Differential	0 - 6	2
9	Backlight	On / Off	Off
10	Degrees F or C	F / C	F
11	Sensor Operation	Yes / No	No
12	Dry Contact Polarity	NO / NC	NO
13	Dry Contact Operation	Unocc. / Off	Unocc.
14	Unocc. Cool Setpoint	35 - 99 , OF	85
15	Unocc. Heat Setpoint	OF, 35 - 99	55

About Advanced Features & Operation



* CALIBRATION - Under normal circumstances it will not be necessary to adjust the calibration of the temperature sensor.

- 1 **MODE**  Place the thermostat in the OFF mode.



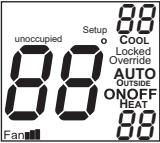

- 2 **MODE**   Press and hold the MODE button. While holding the MODE button, press and hold the DOWN button for 5 seconds. All icons will appear on the display.

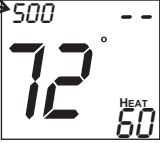

- 3   Press the MODE button once. The thermostat temperature will be displayed and may be calibrated using the UP or DOWN button.

Software Version #



- 4 **MODE**  After calibration is complete, press the MODE button **once** to save your changes and return to normal operation.



About Advanced Features & Operation

* **DEADBAND OPERATION** - Controls one Heat and one Cool stage with a three speed fan (see below).

The **low speed fan** for heat or cool is turned on when: The temperature spread from the setpoint is equal to or greater than: *the setpoint plus the 1st stage deadband (step #7, page 12)*. This 1st stage deadband is adjustable from 1-6 degrees and the default is two degrees.

The **medium speed fan** for heat or cool is turned on when: The temperature spread from the setpoint is equal to or greater than: *the setpoint plus the 1st stage deadband (step #7, page 12), plus the 2nd stage deadband*. This 2nd stage deadband is fixed at one degree and is not adjustable.

The **high speed fan** for heat or cool is turned on when: The temperature spread from the setpoint is equal to or greater than: *the setpoint plus the 1st stage deadband (step #7, page 12), plus the 2nd stage deadband, plus the 3rd stage deadband*. This 3rd stage deadband is fixed at one degree and is not adjustable.

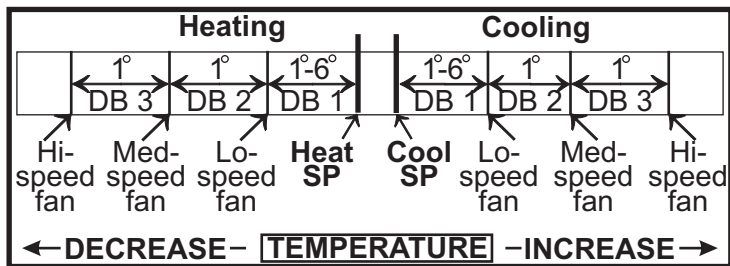

The above figure assumes the minimum on time for the prior stage has been met to allow the next stage to turn on once the deadbands have been exceeded.

About Advanced Features & Operation

- ✿ DRY CONTACT SWITCH - This feature allows an external device such as a Central Time Clock, Occupancy Sensor, or a Telephone activated device to force one or more thermostats into an Unoccupied mode (*steps #12 and 13, page 13 & 14*).

When the CK1 and R terminals are shorted together, and the thermostat is programmed for Unoccupied operation (*step #13, page 14*), the thermostat will be forced into Unoccupied setpoints and the Unoccupied icon will appear on the display.

Important Note: For control of *multiple thermostats by 1 source*, refer to page 28 'Potential Phasing Problems' before installation.

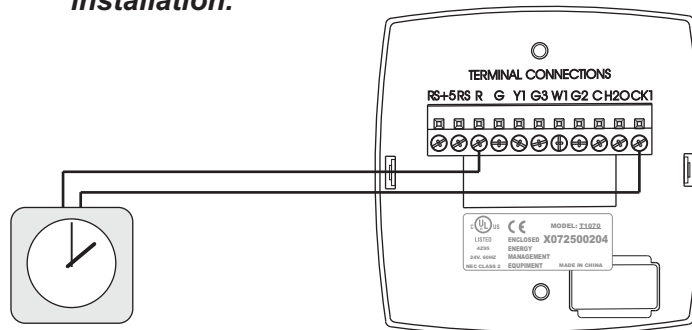

Connect wires to a time clock or other device to force the thermostat into Occupied 1 or Unoccupied settings.

About Advanced Features & Operation

* **FACTORY DEFAULTS** - If, for any reason, you desire to return all the stored settings back to the factory default settings, follow the instructions below.

WARNING: This will reset all Advanced Programming to the default settings. Any information entered prior to this reset will be permanently lost.

- 1**
MODE Place the thermostat in the OFF mode.



- 2**
MODE Press and hold the MODE button. While holding the MODE button, press and hold the DOWN button for 5 seconds. All icons will appear on the display.

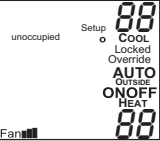

- 3**
FAN After all of the icons appear, release the MODE and DOWN buttons. Then press and hold the FAN button for 2 seconds.



- 4**
MODE After the letters Fd appear on the display (Factory Default), release the FAN button. Press the MODE button **twice** to return to normal operation.



About Advanced Features & Operation

* FAN OPERATION

Fan: When only the fan icon is displayed, this indicates that the fan is in the Auto mode, will only energize during a heating or cooling cycle, and will modulate fan speeds based on temperature demand (see page 17).

Fan■, **Fan■■**, or **Fan■■■** : Pressing the FAN button will cause the low, medium, or high speed fan icon to appear (see page 9), indicating that the fan will run continuously. The fan will de-energize if the thermostat is placed in the Off mode or a dry contact forced unoccupied time period (see page 18).

Notes:

1) *If a Duct sensor is connected to this thermostat, then the fan should be programmed for continuous operation (step #5, page 11). This will provide airflow over the Duct sensor and provide more accurate temperature readings.*

2) *If the fan is programmed for continuous operation (step #5, page 11), the low speed fan will run continuously when the fan is in the Auto mode, but will de-energize if the thermostat is placed in the Off mode.*

- * **MINIMAL DISPLAY** - When the thermostat is programmed for a minimal display (step #1, page 10), the entire display will be blank. When a button is pressed the full, normal display will appear for 10 seconds.

About Advanced Features & Operation

- ✿ HEAT/COOL DIFFERENTIAL - The Heat and Cool setpoints will not be allowed to come any closer to each other than the value set in Advanced Setup *step #8, on page 12*. This minimum difference is enforced during Auto-changeover operation.

Note: To increase the spread between the heating and cooling setpoints in the Auto-changeover mode press the MODE button until only the heat setpoint is displayed; adjust to the desired setpoint. Press the MODE button until only the cool setpoint is displayed; adjust to the desired setpoint. Press the MODE button again to enter the Auto-changeover mode where both the heat and cool setpoints are displayed.

- ✿ KEYPAD LOCKOUT - To prevent unauthorized use of the thermostat, the front panel buttons may be disabled. To disable, or 'lock' the keypad, press and hold the MODE button. While holding the MODE button, press the UP and DOWN buttons together. The LOCKED icon will appear on the display, then release the buttons.

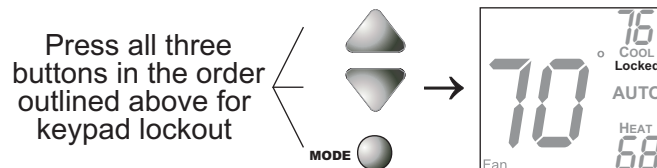

To **unlock** the keypad, press and hold the MODE button. While holding the MODE button, press the UP and DOWN buttons together. The LOCKED icon will disappear from the display, then release the buttons.

About Advanced Features & Operation

- * LOCKING COVER
w/Tamper Proof Screws

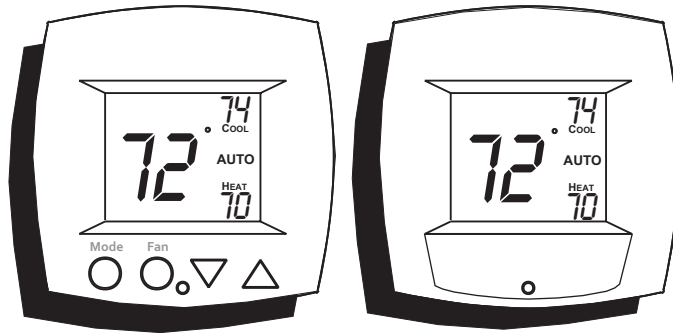

- * OUTSIDE SENSOR - To view an Outside Sensor press and hold the FAN button for two seconds until the Outside icon appears. If an optional outside sensor is connected, the outside temperature will appear on the display. To exit the outside temperature display, press any button.

About Advanced Features & Operation

- * **DUCT SENSOR (P/N ACC0402)** - The thermostat is programmed from the factory to automatically recognize when a Duct Sensor is connected (step #11, page 13).

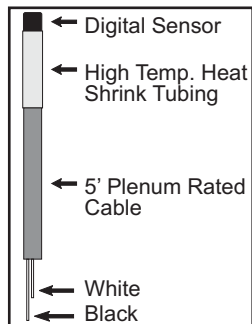

Duct Sensor connections are illustrated on page 27.

Note: *If a Duct sensor is connected to this thermostat, then the fan should be programmed for continuous operation (step #5, page 11). This will provide airflow over the Duct sensor and provide more accurate temperature readings.*

About Advanced Features & Operation

- * SINGLE SETPOINT BEHAVIOR - When configured for *Single Setpoint* operation (*step #2, page 10*), the degree icon will blink when the large number is displaying room temperature and will remain solid when displaying the heating or cooling setpoint. In the Auto mode the deadband is enforced both above and below the setpoint. To avoid short cycling, a deadband of at least two degrees is recommended (*step #7, page 12*). To display the room temperature press and hold the MODE button for two seconds. Release the MODE button to return to the normal display.

- * FAN COIL TYPE - This step instructs the thermostat how to set the G, G2, and G3 outputs to yield the desired fan speeds. Since this is a low voltage thermostat, the fan coil should have multiple relays or contactors to supply the voltages needed for the fan motor. Most fan coils will have 3 relays and require only one relay to be driven at a time. However, many models of Carrier or IEC fan coils contain a relay board with special logic that requires different output settings from the thermostat. If there is any question, please contact the fan coil manufacturer.

Step 6 = OFF			
Speed	G	G2	G3
LO	ON		
MED		ON	
HI			ON

Step 6 = ON			
Speed	G	G2	G3
LO	ON		
MED	ON	ON	
HI	ON		ON

Sample Wiring Diagram

2-Pipe, Low Voltage Valve, H2O Changeover Sensor

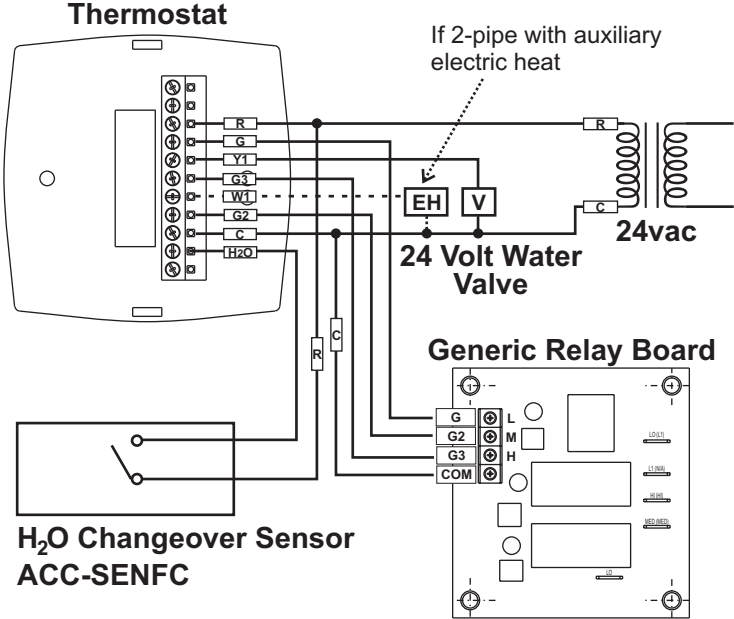

Sample Wiring Diagram

4-Pipe, Low Voltage Valves, Duct Temperature Sensor & Dry Contact

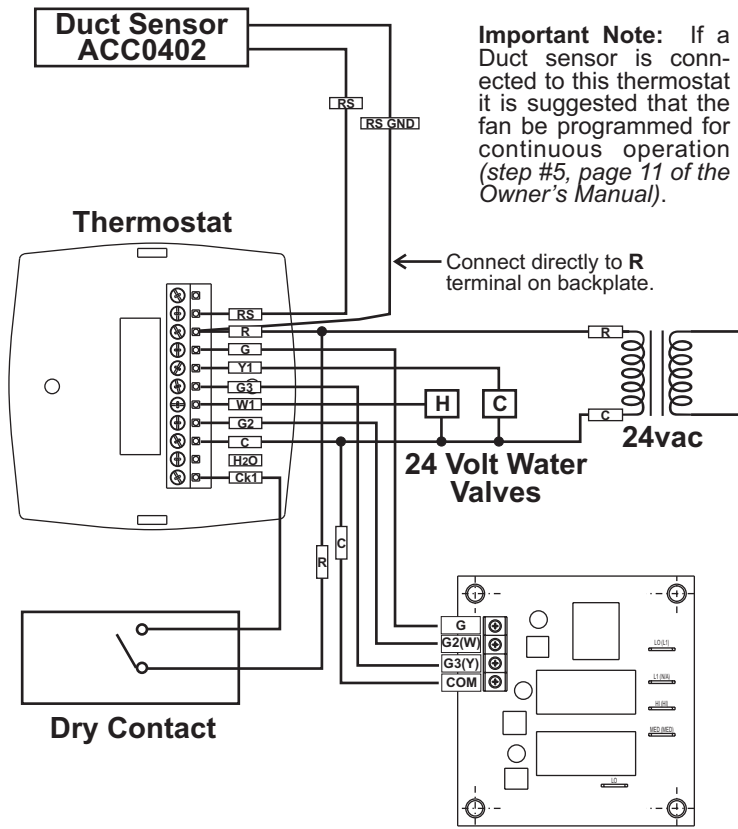

Important Note: If a Duct sensor is connected to this thermostat it is suggested that the fan be programmed for continuous operation (step #5, page 11 of the Owner's Manual).

← Connect directly to R terminal on backplate.

Sample Wiring Diagram

Connection Diagram for Duct Sensor to T1070 Fan Coil Thermostat

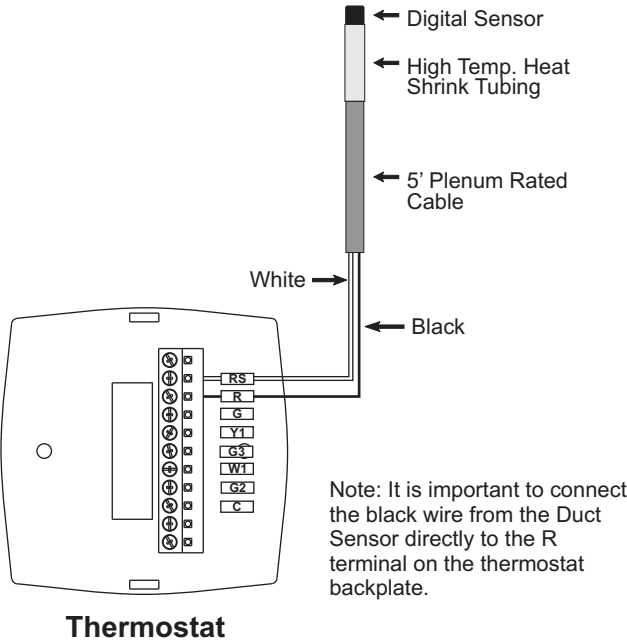

Sample Time Clock Wiring Diagram

Important Information About:



Auxiliary Input Control and Multiple HVAC Control Potential Phasing Problems



When using the auxiliary input (CK1 & R) or controlling multiple HVAC units with a single thermostat, it is possible to encounter transformer phasing problems that will interfere with thermostat operation. Connecting transformers that are not phased correctly may result in a direct short, which could damage transformers and/or the thermostat. Phasing problems are likely if the units share a common ground with secondary grounded transformers.

SOLUTION: If possible, phase all HVAC units together. If phasing is impractical, isolation relays may be used to isolate the transformers. To isolate the auxiliary input, use a separate transformer for the auxiliary control device, (time clock depicted below) Connect the device to an isolation relay coil. Connect one set of isolated contacts to each thermostat at **CK1** and **R**. See diagram A.

Diagram A- Auxiliary Control

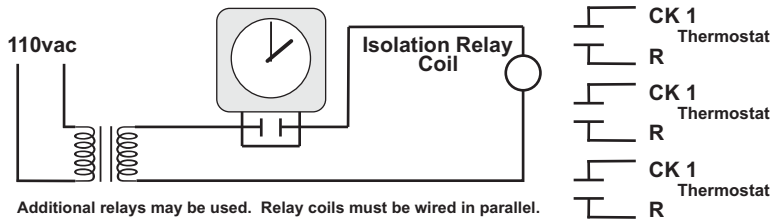

Warranty

One-Year Warranty - This Product is warranted to be free from defects in material and workmanship. If it appears within one year from the date of original installation, whether or not actual use begins on that date, that the product does not meet this warranty, a new or remanufactured part, at the manufacturer's sole option to replace any defective part, will be provided without charge for the part itself provided the defective part is returned to the distributor through a qualified servicing dealer.

THIS WARRANTY DOES NOT INCLUDE LABOR OR OTHER COSTS incurred for diagnosing, repairing, removing, installing, shipping, servicing or handling of either defective parts or replacement parts. Such costs may be covered by a separate warranty provided by the installer.

THIS WARRANTY APPLIES ONLY TO PRODUCTS IN THEIR ORIGINAL INSTALLATION LOCATION AND BECOMES VOID UPON REINSTALLATION.

LIMITATIONS OF WARRANTIES – ALL IMPLIED WARRANTIES (INCLUDING IMPLIED WARRANTIES OF FITNESS FOR A PARTICULAR PURPOSE AND MERCHANTABILITY) ARE HEREBY LIMITED IN DURATION TO THE PERIOD FOR WHICH THE LIMITED WARRANTY IS GIVEN. SOME STATES DO NOT ALLOW LIMITATIONS ON HOW LONG AN IMPLIED WARRANTY LASTS, SO THE ABOVE MAY NOT APPLY TO YOU. THE EXPRESSED WARRANTIES MADE IN THIS WARRANTY ARE EXCLUSIVE AND MAY NOT BE ALTERED, ENLARGED, OR CHANGED BY ANY DISTRIBUTOR, DEALER, OR OTHER PERSON WHATSOEVER.

ALL WORK UNDER THE TERMS OF THIS WARRANTY SHALL BE PERFORMED DURING NORMAL WORKING HOURS. ALL REPLACEMENT PARTS, WHETHER NEW OR REMANUFACTURED, ASSUME AS THEIR WARRANTY PERIOD ONLY THE REMAINING TIME PERIOD OF THIS WARRANTY.

THE MANUFACTURER WILL NOT BE RESPONSIBLE FOR:

1. Normal maintenance as outlined in the installation and servicing instructions or owner's manual, including filter cleaning and/or replacement and lubrication.
2. Damage or repairs required as a consequence of faulty installation, misapplication, abuse, improper servicing, unauthorized alteration or improper operation.
3. Failure to start due to voltage conditions, blown fuses, open circuit breakers or other damages due to the inadequacy or interruption of electrical service.
4. Damage as a result of floods, winds, fires, lightning, accidents, corrosive environments or other conditions beyond the control of the Manufacturer.
5. Parts not supplied or designated by the Manufacturer, or damages resulting from their use.
6. Manufacturer products installed outside the continental U.S.A., Alaska, Hawaii, and Canada.
7. Electricity or fuel costs or increases in electricity or fuel costs for any reason whatsoever including additional or unusual use of supplemental electric heat.
8. ANY SPECIAL INDIRECT OR CONSEQUENTIAL PROPERTY OR COMMERCIAL DAMAGE OF ANY NATURE WHATSOEVER. Some states do not allow the exclusion of incidental or consequential damages, so the above may not apply to you.

This warranty gives you specific legal rights and you may also have other rights which may vary from state to state.