



DELUXE
PROGRAMMABLE
THERMOSTATS

Models 9701i, 9715i and 9720i

Quick Start Installation Manual



111-284C

Installation DOs and DON'Ts

DO

- Shut off all power to system before installing.
- Read entire manual before installing.
- Make sure that all wiring conforms to national and local codes.

DO NOT

- Install on voltages greater than 30 VAC.
- Short jumper across terminals on the gas valve or at the system control.
- Install on outside walls or in direct sunlight.

① Select location for installation.

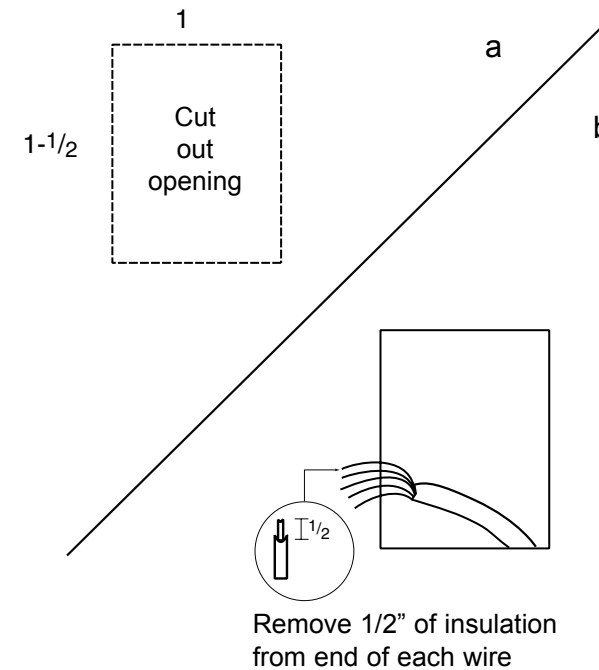

② Open the case with a screwdriver. Place in slot and gently pry forward at all four locations.

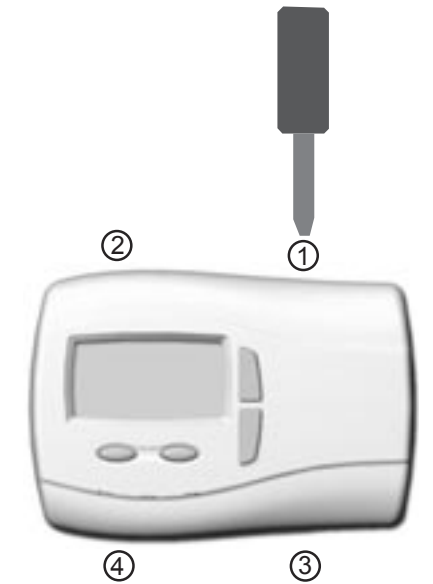

③ Mark mounting hole locations on wall.

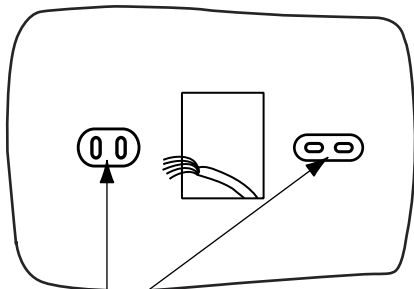

Mark mounting hole locations on wall using unit base as template.

④ Drill 3/16" holes at marked locations on wall. Insert plastic anchors into holes.

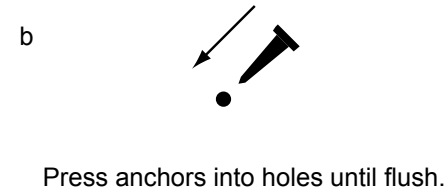
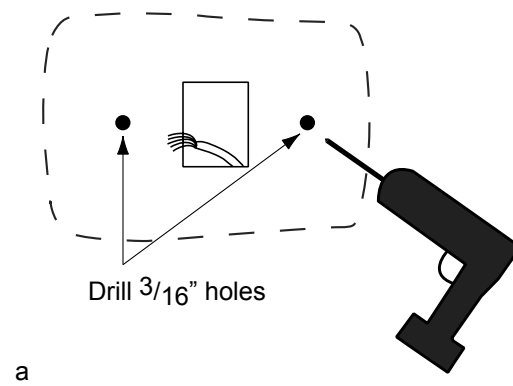

⑤ Align unit base over plastic anchors embedded in wall and secure with the screws provided.

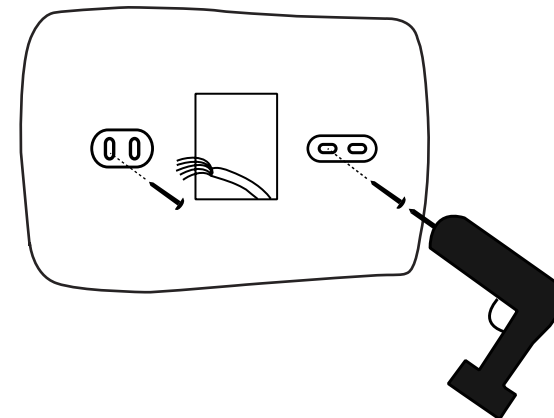

⑥ Connect wiring between unit and furnace. For Model 9701i (1H/1C gas/electric furnace and single stage heat pump applications):

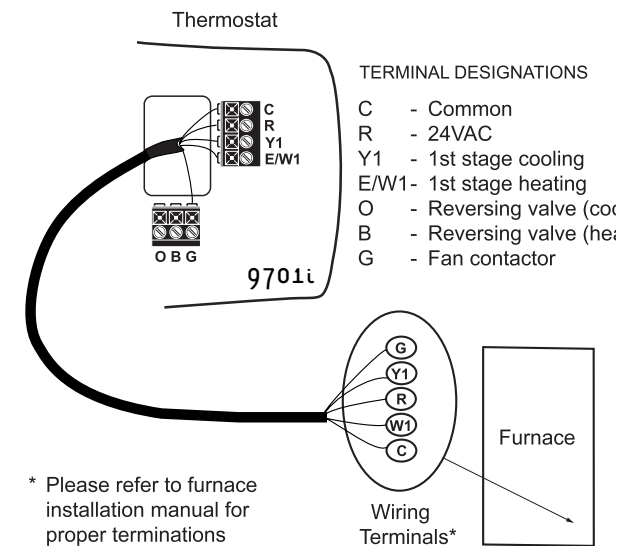

7 **NOTE:** For 9701i single stage heat pump applications, place a jumper between the W1 and Y1 terminals.

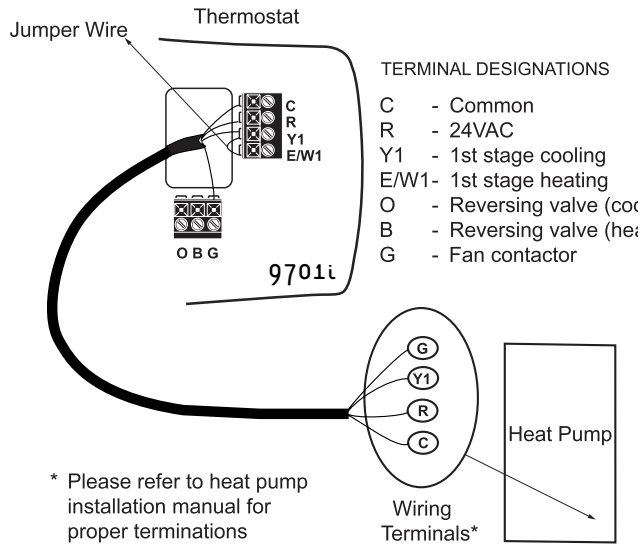

8 Connect wiring between unit and furnace. For Model 9715i (2H/2C gas/electric furnace applications):

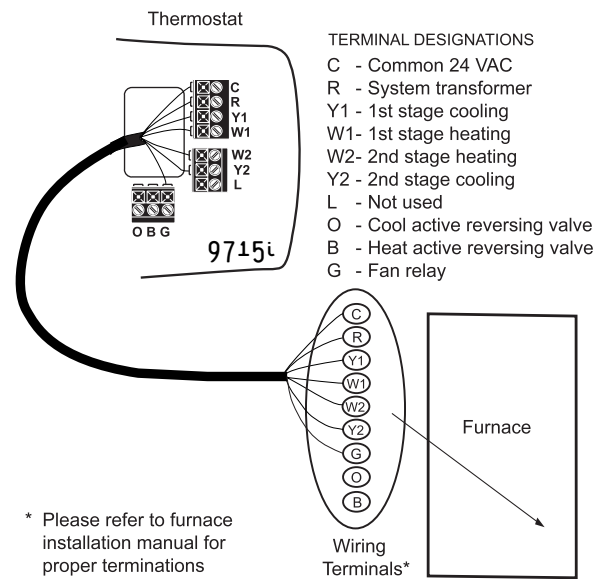

9 Connect wiring between unit and furnace. For Model 9720i (2H/2C heat pump applications):

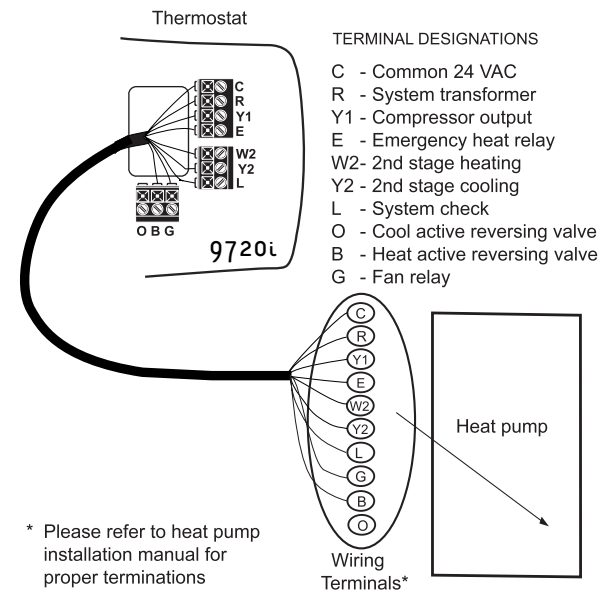

10 Connect wiring between the thermostat and the indoor sensor (9020i) and the outdoor sensor (9025i), if used. Use twisted pair wiring (22AWG minimum) with a maximum length of 300 feet (or 100m).

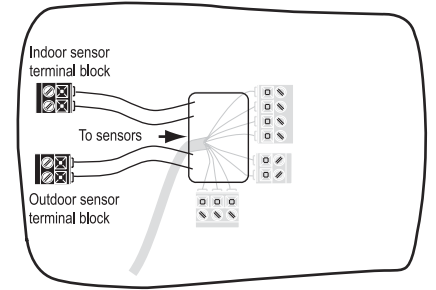

11 Replace cover on thermostat. Turn on power to unit and proceed with programming per instructions on the display or in the user's manual.

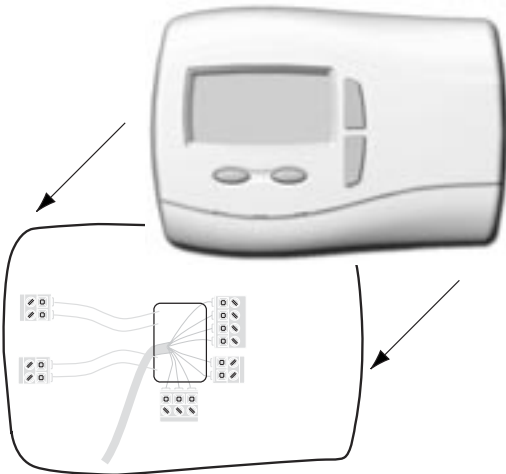

12 **Set Your Name**

To set your name and phone number into the thermostat press MENU, select INSTALLER SETTINGS, and CONTACT INFORMATION. The screen at the bottom left should appear.

To enter your name press EDIT. Use the UP or DOWN button to scroll through the characters. (DOWN gets you to the letters faster.) After each letter press NEXT.

When you are done entering your name, press ACCEPT.

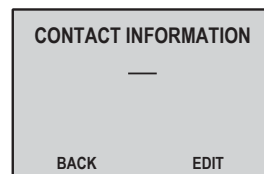

13 **Set Your Phone Number**

Now enter your phone number. Use the UP and DOWN arrow to select the first number. Press NEXT. When you have completed entering your phone number, press ACCEPT.

The screen will return to the INSTALLER SETTINGS. Finish setting the thermostat for the application.

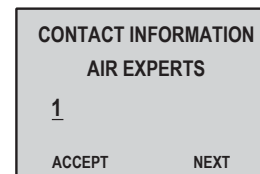

515 South Promenade Avenue
Corona, CA 92879-1736
United States of America
Made in Mexico
www.about-i-series.com