

Air Purifier

Operation Instruction Manual

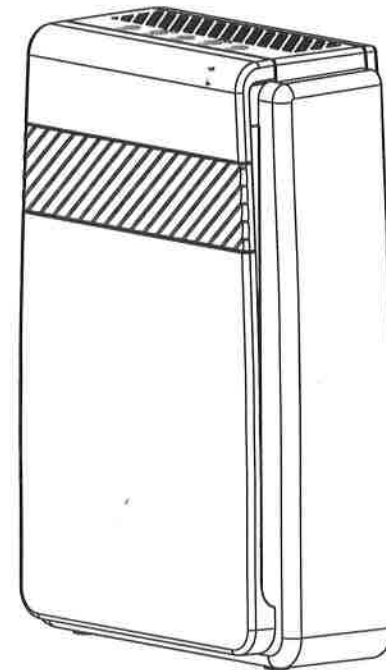

Catalogue

Product Feature	1
Product Component	2
Application Method	4
Cleaning and Maintenance	6
Warning	7
Frequently Asked Questions	10
Technical Specification	11
After-sales Service	14

- Please Carefully read this operation instruction before use.
- The company reserves the final interpretation right of this operation instruction.
- Product appearance shall be subject to material object.
- Please keep it properly with your invoice after reading.
- Products shall be subject to technology or software upgrades without additional notices.

Product feature

Purification Process

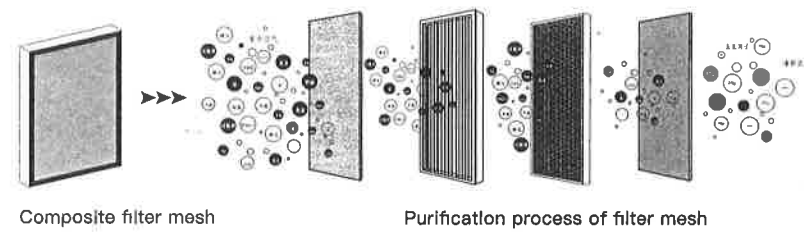

Composite filter mesh can firstly filter out large contamination particles such as hairs and pet hairs, and then can effectively remove minor contamination particles such as PM 2.5 and smog through high efficient HEPA filter mesh. Next, it can filter out mites and allergen through anti-mite and anti-allergic filter mesh among which activated carbon can effectively filter out harmful gas such as formaldehyde and benzene and strongly remove peculiar smell and foul smell, while negative oxygen ion generator can release much negative oxygen ion to refresh room air.

Auxiliary Function

Buzzer: When the machine is powered on and under operation, the buzzer makes a prompt tone with buttons being pressed.

1

Product components

Product components

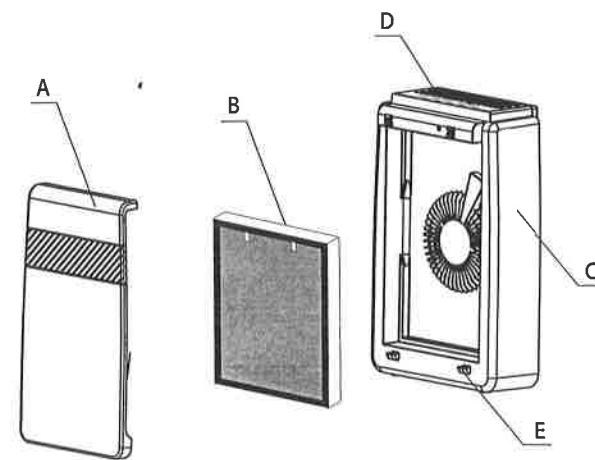

A : Panel

C: Screen

E: Air Duct

B: Composite filter mesh

D: Touch function button

2

Product components

The Fuselage Control schematic diagram

Panel Instruction

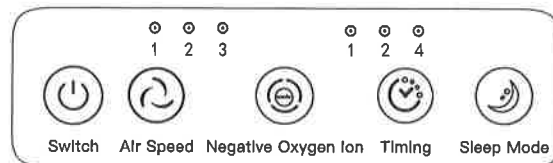

Function Brief Instruction

1. Switch: Touch[switch button],switch on/off.
2. Air Speed: Circularly touch [air speed] button, air speed circularly switch from level two → level three → level one circularly.
3. Negative Oxygen Ion: Touch[Negative Oxygen Ion]button, open or close the function of Negative Oxygen Ion.
4. Timing button: Circularly press the button with the machine on or off, one can choose the timing time circularly and switch the timing time from 1: 00→2: 00→4: 00→ non-timing→1: 00. After 2 seconds of displaying, the countdown comes. After timing:
 - (1) Timed power off: with the machine on, It automatically turns off.
 - (2) Timed power on: with the machine off, it automatically turns on.
5. Sleep mode: Touch[Sleep]button to enter sleep mode.

Application Method

Before First Use

Packaging bag must be torn off before use. Then filter mesh shall be installed in the machine correctly.

- ⊙Before operating the device, please put it 2 meters away from equipment with electric wave (such as television, radio or clock) to avoid interference of electric wave.
- ⊙Please do not install it at the place where object such as curtain may block air inlet or outlet, otherwise the component may be polluted or the device may get out of order.
- ⊙Please do not install it at the place where the device is exposed to condensation environment directly because of severe temperature change.

Please use it when the room temperature is suitable and varies from 0 to 35 degree centigrade.

- ⊙The device must be stably installed and well-ventilated.

When the device is put on the ground covered with sick carpet, it may shake slightly.

- ⊙Please do not install it at the place where black smoke is produced (such as kitchen and so forth).

- ⊙Certain space shall be guaranteed around the air purifier.

Putting the device at the place with natural flow of wind can lead to better purifying effect. Furthermore, it can make sure that negative oxygen ion can arrive at every corner of the room smoothly.

Dismantling the filter mesh

1. Dismantling the front cover: Grasp both sides of the upper part of front cover with both hands, then lift it up before drag it towards your own direction. The front cover then drops off the device body (Do not overexert in case of damage to the front cover). (Picture one)
2. Dismantling the composite filter mesh: hold the composite filter mesh and drag it towards your own direction. The composite filter mesh then can be took down. (Picture two)

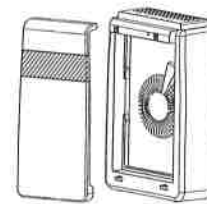

Picture one

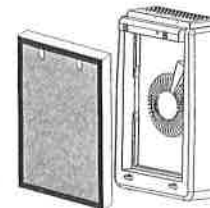

Picture two

Application Method

Installment of filter mesh

1. Installment of composite filter mesh: With one side with handle towards the outside, put the filter mesh in and install it well. (Picture three)
2. Installment of font cover: Link the bottom side of front cover firmly with the device body, then align the front cover with two slots. Equipment of the main body will be linked with the front cover.

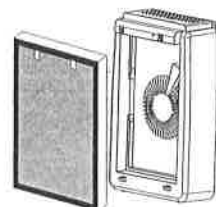

Picture three

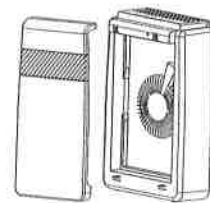

Picture four

Re-installment of filter mesh

- (1) Indication: When the life span of the filter mesh accumulates to a maximum, set up 1H,2H,4H, 3 LED lights flicker simultaneously.
- (2) Re-installment: After replacing the filter mesh, keeping pressing the "timing+wind speed" bottom for 3 seconds to reset when the device is on. Buzzer rings for once and meanwhile the state of indication flashing light relieved, the device counts time once again.



This marking indicates that this product should not be disposed with other household wastes throughout the EU. To prevent possible harm to the environment or human health from uncontrolled waste disposal, recycle it responsibly to promote the sustainable reuse of material resources. To return your used device, please use the return and collection systems or contact the retailer where the product was purchased. They can take this product for environmental safe recycling.

Cleaning and Maintenance

Cleaning and Maintenance

Unplug the device each time before cleaning.

1. Cleaning the device body

- 1) Clean the stains using only soft cloth.
- 2) To clean stubborn stains that are not easily to be wiped out, use soft cloth with Proper amount of neutral detergent to clean.

Caution: Do not scratch device casing under maintenance with hard objects. When removing surface cover, please operate in accordance with the instruction manual and do not damage device components.

Cleaning and Change of Filter Mesh

- 1) The change of filter mesh is reminded by built-in program. But because of different pollution extent of actual environment, the life span of filter mesh differs. One can promptly change filter mesh according to the voice volume or the smell produced by the device. Suggestion: Clean once every two months. If the air is heavily polluted, one should improve cleaning frequency.
- 2) When dust accumulates on composite filter surface, one may use vacuum cleaner to remove dust from the surface to lengthen the life span of filter mesh. (Suggest cleaning once every two month)

	Replacement Intervals	Condition
Composite filter mesh	Replace the filter mesh once every two months	Absorb emissions of six cigarettes every day

*The replacement intervals of filter mesh may shorten according to different places and methods of usage(eg. family with more smokers). In a word, please promptly change the filter mesh when it performs poorly.

*Please dispose of the used filter mesh as Non combustible waste

Technical Specifications

Main Technical Parameter





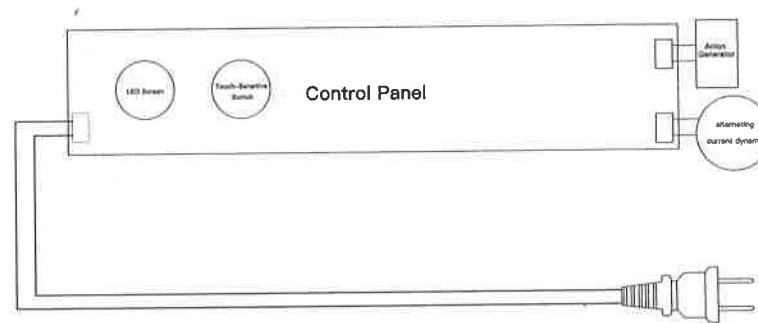

Product Name	Air Purifier Model	Number	
Rated Voltage	AC 100~120V	Incoming Frequency	60Hz
Rated Input Power	45W	Noise	≤61dB(A)
Particulate Matter Clean Air Delivery Rate(CADR pm)		188 m ³ /h	
Particulate Matter Cumulate Clean Mass (CCM pm)		P1	
Particulate Matter Purification Energy Efficiency		4.18(Qualified level)	
Applying Area		22m ²	
Product Size		537.5x340x166mm	
Net Weight	5.0kg	Gross Weight	6.3kg

Electrical Schematic Diagram



Notice: Please go to the professional repair personnel or manufacturer to check or replace the power supply to avoid danger.

Warning

<p> When using this product, please do not use it near or on heat sources (such as fireplace, stove or place easy to get access to inflammable gas).</p>	<p> Please do not wipe this product with ethyl alcohol, organic solvent, otherwise it may cause damage to the product or electric shock that may lead to injury or fire disaster.</p>
<p> This sign suggest that there is possiblity to cause injury or material damage.</p>	<p> When moving this device please hold handle on both sides of the device firmly. ·When moving this device, holding the front cover may lead to the falling-off of the cover. Falling down of device body can cause personal injury.</p>
<p> If this air purifier causes any interference to radio or television, please try the following one or multiple measures to correct interference: ·Readjust or rotate receiving antenna. ·Please lengthen the distance between air purifier and radio/television. ·Please connect power of the device and acceptor separately with different mains socket. ·If you need any assistance, please contact dealers or professional technical personnel of radio or television.</p>	<p> This device is not suitable for the disabled, the perceptual handicapped, the mental handicapped or children to operate alone. On-site supervision or guidance provided by safety directors to operate this device makes an exception.</p>

Frequently Asked Questions

Frequently Asked Questions	
Failure Phenomenom	Possible Reasons and Solutions
Failure to start the device	Failure to start the device
Little volume of air from air outlet	<ol style="list-style-type: none"> 1、Packaging bag of filter mesh is unpacked. Remove the packaging bag and install filter mesh again. 2、Air inlet or outlet is blocked by foreign matters. Remove them. 3、Filter mesh is dirty. Clean or replace it.
Not apparent dust removal and purifying effect Not obvious improvement of air quality	<ol style="list-style-type: none"> 1、Filter mesh is not installed on the device. Install the filter mesh. 2、Window or door is frequently opened. In the room with slow air flow, because the outside dirty air comes in, it takes a longer time to purify the indoor air. 3、The device is put in a crowded place or near obstacles, and thus affects purifying effect. 4、The filter is filthy, and thus affects purifying effect. Clean or replace it.
Peculiar Smell from the air outlet	<ol style="list-style-type: none"> 1、lots of smokers in the room or barbecue can lead to plenty of odor. Suggest you ventilate the room. 2、Filter mesh is quite filthy. Change a brand new filter mesh.

Notice: If one is unable to remove faults through the above exams, please contact the maintenance networks or technical service center provided by our company customer service center. Please do not dismantle and repair it on one's own to avoid dangers and possible damage to the device.



Warning

Notice: All the content in this part is concerned with safety and shall be strictly followed by the user.

Matters need attention in this part is for the right usage of this product.

Matters need attention explain dangers, extent of injury and possible accidents.













- 1、 Do not use other accessories without permits of the manufacturer. If it causes malfunction of the device, the warranty shall automatically terminate.
 - 2、 After unpacking, please check whether the product is damaged and accessories are complete.
 - 3、 Children and people without capacity for civil product should be supervised by their guardians to use this product.
 - 4、 In the case of malfunctions ,disconnect the device from the mains socket immediately. Do not maintain the defected product in working state.
 - 5、 This product can only be repaired by Haier's authorized maintenance center. Repair in non-authorized maintenance center may cause other insecurities.
- If power cord damages, it shall be replaced by the specialist personnel of the manufacturer, its maintenance department or similar departments to avoid dangers.

	Action with this sign is strictly prohibited. Otherwise it may cause damage to the product or endanger the personal security of the user.
	Action with this sign should be strictly operated according to the instruction. Otherwise it may cause damage to the product or endanger the personal security of the user.
	Action with this sign should be paid attention by the user. Otherwise operation error can cause damage to the product or other losses.

 Do not insert your finger or foreign matters in air inlet or air outlet

 Do not disconnect or connect mains socket

Warning

	Please do not use air purifier in the environment full of inflammable gas such as hydrogen, natural gas and propane.		Please do not use air purifier when the power cord or plug is damaged or the power outlet on the wall gets loose.
	When using aerosol bomb, Please do not use this product. When there is oil residue, smoke produced by burning incense, flame produced by lighting up cigarettes, chemicals odors in the room, please do not use this product. Please do not use this product where the moisture is very heavy.		Please do not block air inlet or air outlet.
	please do not operate this device without installing filter.		Please do not clean or reuse composite filter mesh.
	Only standard power outlet with 220v voltage can be used		When disconnecting plug, please hold the plug firmly and do not drag power cord, otherwise it may cause electric shock or fire disaster led by short circuit.
	When cleaning or stop using this product, please disconnect plug from power outlet, otherwise it may cause electric shock led by defective insulation or fire disaster led by short circuit.		Regularly clean dust on plug
	One shall be careful when cleaning air purifier because strong corrosive detergent may damage the product's surface.		Use only soft cloth to clean the product's surface, otherwise the product may get damaged or cracked down.