



1-800-588-4470

900 Hamel Road, Hamel, MN 55340

Infloorboard™

APPLICATION AND INSTALLATION MANUAL

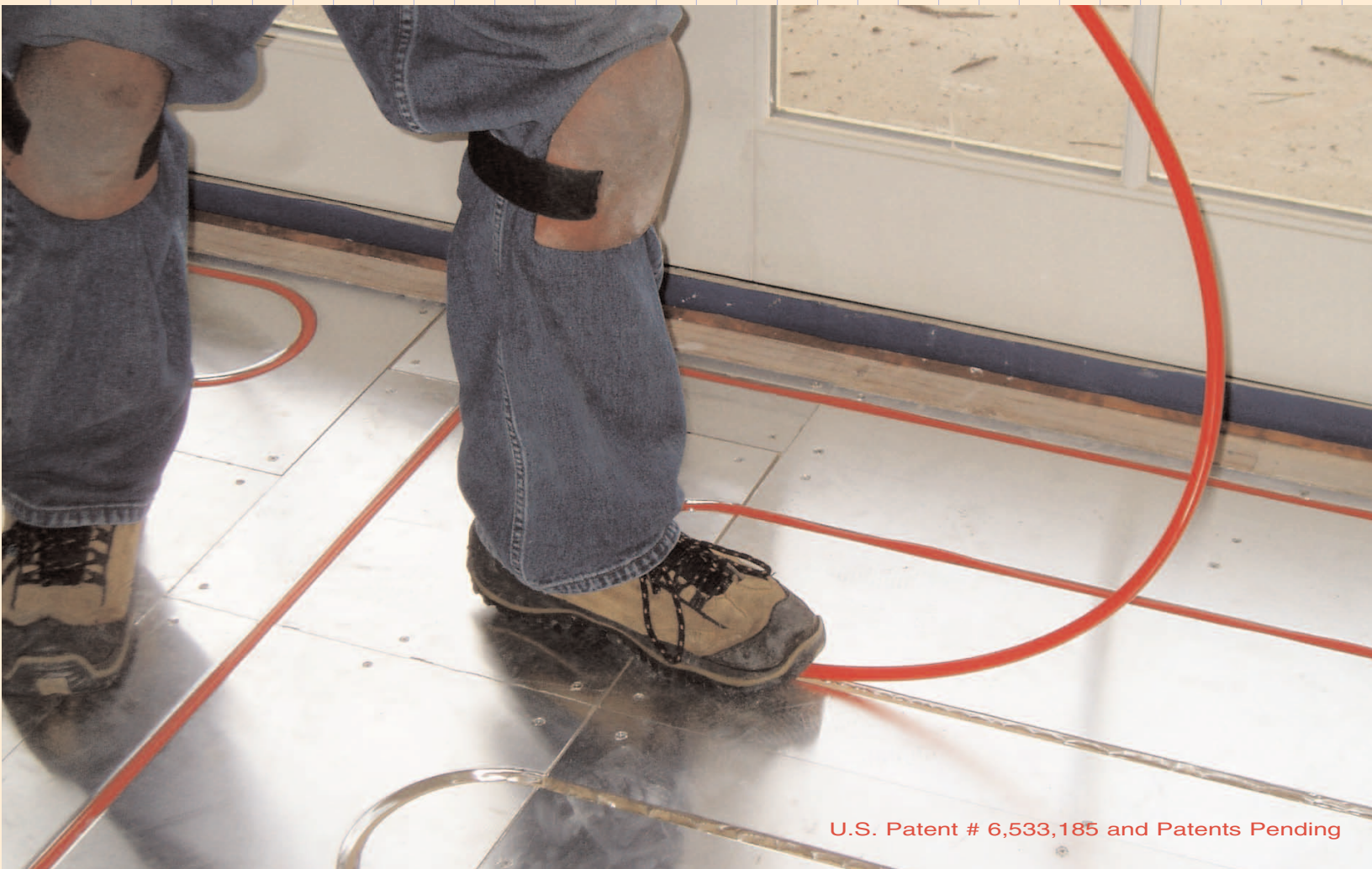

U.S. Patent # 6,533,185 and Patents Pending

www.Infloor.com

APPLICATION AND INSTALLATION MANUAL-TABLE OF CONTENTS

INTRODUCTION	PAGE 3
ADVANTAGES OF INFLOORBOARD™	PAGE 5
DESIGN AND PERFORMANCE	PAGE 6
FLOORING GOODS R-VALUES	PAGE 7
SYSTEM OUTPUT	PAGE 8
IMPORTANCE OF CAD LAYOUTS	PAGE 8
ESTIMATING REQUIRED NUMBER OF INFLOORBOARD™ BOARDS	PAGE 9
TUBING AND LOOP LENGTHS	PAGES 9-10
INSTALLATION-UNDERSTANDING THE PRODUCT	PAGES 11-12
HOW TO SPACE THE BOARDS	PAGE 12
ALIGNING AND ATTACHING THE BOARDS	PAGES 13-14
SUBFLOOR REQUIREMENTS: WOOD SUBFLOORS	PAGE 15
EQUIPMENT FOR INSTALLATION OVER WOOD SUBFLOORS	PAGE 16
INSTALLING TUBING IN GROOVES	PAGE 17
EXAMPLE LAYOUT AND INSTALLATION	PAGES 18-29
CONNECTIONS AT MANIFOLD	PAGE 20
INFLOORBOARD™ INSTALLED OVER WOOD SUBFLOOR	PAGE 21
CARPET OVER INFLOORBOARD™-WOOD SUBFLOORS	PAGE 22
VINYL OVER INFLOORBOARD™-WOOD SUBFLOORS	PAGE 22
THINSET TILE OR STONE OVER INFLOORBOARD™ WOOD SUBFLOORS	PAGE 23
MORTAR SET TILE OR STONE OVER INFLOORBOARD™ WOOD SUBFLOORS	PAGE 24
LAMINATE FLOORING OVER INFLOORBOARD™-WOOD SUBFLOORS	PAGE 25
ENGINEERED FLOATED WOOD OVER INFLOORBOARD™ WOOD SUBFLOORS	PAGE 25
STRIP HARDWOOD OVER INFLOORBOARD™ WOOD SUBFLOORS	PAGES 26-27
OTHER WOOD OPTIONS OVER INFLOORBOARD™ WOOD SUBFLOORS	PAGE 28
APPLICATION OF INFLOORBOARD™ TO WALLS OR CEILING	PAGE 29
INSTALLING INFLOORBOARD™ OVER CONCRETE, IMPORTANT CAUTIONS	PAGE 30
FLOORING EXCEPT STRIP WOOD ON INFLOORBOARD™ CONCRETE SUBFLOOR	PAGE 31
STRIP WOOD ON INFLOORBOARD™ CONCRETE SUBFLOOR	PAGE 32
INFLOORBOARD™ CAUTIONS AND LIMITATIONS OF USE	PAGE 33
DESIGN SERVICES: ENERGY CALCS, TUBING AND MECHANICAL LAYOUTS	PAGES 34-36
SAMPLE CAD GENERATED INFLOORBOARD™ LAYOUT	PAGE 37

Installer Caution:

This manual is deemed to be current at the time of publication. It is the installers responsibility to install according to the most current Application Guide. This guide does not purport to address all relevant issues; it assumes a knowledge of good practice in both hydronics and construction methods. Installers should always consult all relevant local, regional and national codes, and adhere to good construction practice. Infloorboard™ should only be installed by knowledgeable qualified installers. Infloorboard™ installations frequently require the coordination of trades. These are, most typically, mechanical and flooring trades. Any issues regarding this coordination should be worked out in advance. Failure to follow the instructions of this guide, failure to adhere to relevant local, regional and national codes, failure to coordinate trades and failure to follow good construction practice may cause an unsatisfactory result. See also "limitations of use" elsewhere in this publication. The limitations and instructions of use for PEX pipe and other hydronic components provided by the manufacturers shall also be referenced and followed during installation; this manual does not address many aspects of a hydronic installation.

INFLOORBOARD™ APPLICATION AND INSTALLATION MANUAL © JUNE 2,, 2004 VERSION 4.

INFLOORBOARD™ IS SOLD UNDER LICENSE FROM WARM BROTHERS INC.

U.S. PATENT # 6,533,185 AND OTHER PATENTS PENDING.

INTRODUCTION



With Infloorboard™, the hydronic radiant heating that everyone loves is now more efficient, more responsive and compatible with standard construction practices. Ideal for new construction and remodeling alike: low profile, light weight and rapid response.

Infloorboard™ delivers a genuine advance in the best heating system you can

buy... hydronic radiant heat.

WHY IT WORKS SO WELL

Non-structural Infloorboard™ is designed specifically for subfloor applications. Infloorboard™ is constructed of a dense composite board covered with aluminum that spreads the heat evenly and quickly from the hydronic tubing. Infloorboard™ heats rapidly and is easy to control with setback thermostats for maximum energy efficiency. It contains just enough thermal mass to be effective, but not so much that it's difficult to control. No other product offers this combination of performance, ease of installation and cost-effectiveness.

Quick Response

- *Low profile, light weight for easy installation*
- *Avoid the moisture, weight and mess of gypsum cement or concrete*
- *Radiant installations, big or small, can be easily scheduled with no lost time for concrete curing*

Infloorboard™ is typically glued and screwed, or stapled to a wood subfloor. Then PEX pipe, which will carry warm water, is snapped into the groove. Heat is transferred from the pipe to the aluminum and the board. Infloorboard™ is manufactured from MDF (medium density fiber board), or dense OSB (oriented strand board), which are relatively conductive wood products weighing 44-50 lbs. per cubic foot. The board is grooved and then laminated with a top layer of

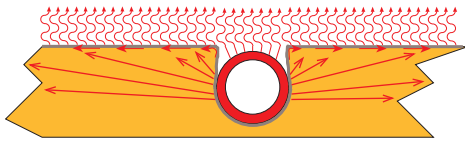

Illustration A-1

ACCELERATION

Acceleration is a measure of how fast a radiant heating system responds. Aluminum is approximately 1000 times more conductive than wood. The layer of aluminum on

Infloorboard™ and in the groove significantly enhances both the transfer of heat and evenness of heat distribution of the board. See Illustration A-1 to see how the heat transfers through Infloorboard™. The thin profile and relatively high density contributes to the superior acceleration and deceleration of Infloorboard™.

Traditional radiant heating systems in concrete work well, but they must first charge a large thermal mass before heat will begin to radiate from the panel. They accelerate and decelerate very slowly due to the large thermal mass, and they can be hard to control. Infloorboard™, being thin, but relatively dense, and aided by its conductive aluminum layer, responds very rapidly. This results in greatly improved response time, with almost no overheating since there is almost no “thermal lag” to overcome. Infloorboard™ can be controlled with standard set-back thermostats.

INFLOORBOARD™ WARMCOAT:

The Infloorboard™ Warmcoat aluminum top layer provides multiple benefits. It is highly conductive. This Warmcoat aluminum layer is also moisture resistant. When the edges and grooves of the Infloorboards™ are sealed using silicone caulking, it provides significant moisture protection for the board. And it provides a barrier to the transmission of any outgassing from the board. Infloorboard™ is manufactured to meet the Federal Housing Authority (FHA) outgassing standard of less than 0.3 ppm of formaldehyde. Independent laboratory tests with 144F° water indicate that, due to the aluminum Warmcoat layer, Infloorboard™ has virtually no detectable levels of outgassing.

ADVANTAGES OF INFLOORBOARD™



Hydronic radiant heating is the most comfortable and efficient way to heat your home or building, with numerous construction benefits and unsurpassed flexibility in zoning. For many years, typical applications for radiant systems involved embedding tubing in concrete slabs or pouring “lightweight concrete” over tubing stapled to sub-floors. The lack of good alternatives to these types of systems permitted designers to overlook the limitations and disadvantages of concrete systems. Infloorboard™ provides that alternative. It is

designed for the application of hydronic radiant tubing over a variety of construction types. Infloorboard™ may be used in new construction and is also advantageous in the growing retrofit market. While only adding 5/8” to the existing floor height, Infloorboard™ provides a superior performing radiant heating system. In addition, application of the system is made easy because only three types of pieces are required for installation.

CONSTRUCTION FRIENDLY

Infloorboard™ avoids joist upsizing, double plating and hardwood nailing strips associated with gypsum-based concrete radiant heating systems. Also, Infloorboard™ eliminates substantial drying costs required by moisture-laden concrete and gypsum-based cement. Time is money. Infloorboard™ eliminates scheduling and curing

COST FRIENDLY

Infloorboard™ is installed using conventional construction practices and commonly used tools. With a layout plan, the three Infloorboard™ panel patterns can be systematically arranged on the subfloor. Not only are the boards light weight -- they're also easy to

FLOORING FRIENDLY

Infloorboard™ provides a quality flat surface for floor covering assemblies. Each of these flooring assemblies is supported by detailed drawings and instructions such as those illustrated in our application guide.

- Hardwood
- Engineered Wood
- Tile/Stone
- Carpet
- Vinyl/Resilient Flooring

PLANET FRIENDLY/GREEN PRODUCT

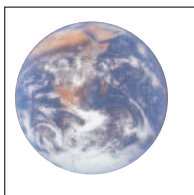

Infloorboard™ is made with Green Cross Certified Medium Density Fiberboard (MDF), which is manufactured with recycled wood products. The glue is a zero VOC, and the aluminum layer may be recycled. The MDF used in Infloorboard™ has less than HUD minimum Formaldehyde content, and the aluminum layer is a positive barrier to outgassing of formaldehyde. A report by Environmental Analysis Incorporated has

DESIGN AND PERFORMANCE

HEAT LOSS ANALYSIS AND SYSTEM DESIGN

Systematic heat loss and design for the structure to be heated should be done prior to any Infloorboard™ installation. As with all floor heating jobs, a detailed and accurate heat loss must be calculated in order to determine proper design conditions. This may be provided by a design service (see Design Services pages). Refer to the 1999 Radiant Panel Association Guidelines for the Installation of Radiant Panel Systems for standards on insulation and heat loss.

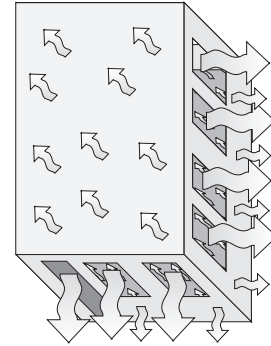

Illustration A-2: Account for all heat losses of the building

DESIGNER'S NOTE

Perform the heat loss analysis of the structure at the design stage. This way, selection of floor coverings can be made with the system requirements in mind. If the heat loss is too high, add insulation or auxiliary heat. In a very high heat loss room, Infloorboard™ can be added to the walls or ceilings for extra heat.

R-VALUE OF FLOOR ASSEMBLIES

While Infloorboard™ will work with a wide variety of floor coverings over the top of the boards, it is important to realize that all floor coverings offer a resistance to heat transfer typically measured by their R-Value. As with all radiant systems, the higher the R-Value of the floor covering, the higher the average water temperature it takes to overcome this resistance and to generate the desired amount of heat. If the R-value of any covering on top of Infloorboard™ is excessive, as with any radiant heating system, performance will be compromised due to lack of heat transfer, or would require exceeding the 150F° maximum supply water temperature. The maximum recommended supply water temperature for Infloorboard™ is 150°F.

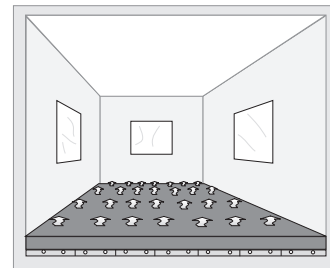

Illustration A-3: Always account for the resistance of floor coverings

DESIGNER'S NOTE

Remember average water temperature means the average of the supply and return water temperatures flowing to and from the loop. Most typically, Infloorboard™ is designed with a 20F° temperature drop. This means the supply water temperature would typically be 10F° higher than the average water temperature.

TYPICAL R-VALUES OF FLOORING GOODS AND MATERIALS

Material	Typical R-Value	R-Value Per Inch	Typical Thickness
Plywood	0.825	1.10	0.750
Plywood Underlayment (1/4")	0.275	1.10	0.250
Softwood	0.825	1.10	0.750
Sheet Vinyl	0.200	1.60	0.125
Vinyl Composition Tile (VCT)	0.200	1.60	0.125
Linoleum	0.400	1.60	0.250
Linoleum	0.200	1.60	0.125
Dense Rubber Flooring	0.250	1.30	0.325
Recycled Rubber Flooring	1.100	2.20	0.500
Cork	1.125	3.00	0.375
Cork/MDF/Laminate	1.175	2.35	0.500
Brick	3.375	2.25	1.500
Marble	0.400	0.80	0.500
Ceramic Tile	0.250	1.00	0.250
Thinset Mortar	0.050	0.40	0.125
MDF/Plastic Laminate	0.500	1.00	0.500
Laminate Floor Pad	0.300	1.92	0.160
Engineered Wood	0.250	1.00	0.250
Engineered Wood	0.375	1.00	0.375
Engineered Wood	0.625	1.00	0.625
Engineered Wood	0.750	1.00	0.750
Engineered Wood Flooring Pad	0.200	1.60	0.125
Engineered Bamboo	0.720	0.96	0.750
Oak	0.638	0.85	0.750
Ash	0.750	1.00	0.750
Maple	0.750	1.00	0.750
Pine	0.975	1.30	0.750
Fir	0.900	1.20	0.750
Carpet Pad/Slab Rubber 33lb	0.320	1.28	0.250
Carpet Pad/Slab Rubber 33lb	0.480	1.28	0.375
Carpet Pad/Slab Rubber 33lb	0.640	1.28	0.500
Carpet Pad/ Waffle Rubber 25 lb	0.620	2.48	0.250
Carpet Pad/Waffle Rubber 25 lb	1.240	2.48	0.500
Hair Jute	1.940	3.88	0.500
Hair Jute	1.250	3.88	0.325
Prime Urethane	1.400	4.30	0.325
Prime Urethane	2.150	4.30	0.500
Bonded Urethane	1.350	4.20	0.325
Bonded Urethane	2.100	4.20	0.500
Carpet	0.700	2.80	0.250
Carpet	1.050	2.80	0.375
Carpet	1.400	2.80	0.500
Carpet	1.750	2.80	0.625
Carpet	2.100	2.80	0.750
Wool Carpet	1.575	4.20	0.375
Wool Carpet	2.100	4.20	0.500

SYSTEM OUTPUT

Chart C-1, can be used to estimate system output with different floor coverings. This chart shows the steady state performance of Infloorboard™. To the left are the BTU/Sq. Ft/Hour. The diagonal lines represent the resistance of the floor coverings on top of Infloorboard™. Along the bottom is the average water temperature required to achieve the output. The chart is read by selecting the correct BTU requirement and then moving horizontally until you find the line indicating the correct R-Value of the floor assembly on top of Infloorboard™. At that point, drop down vertically to see average water temperature. See the previous page for a list of estimated floor covering R-Values.

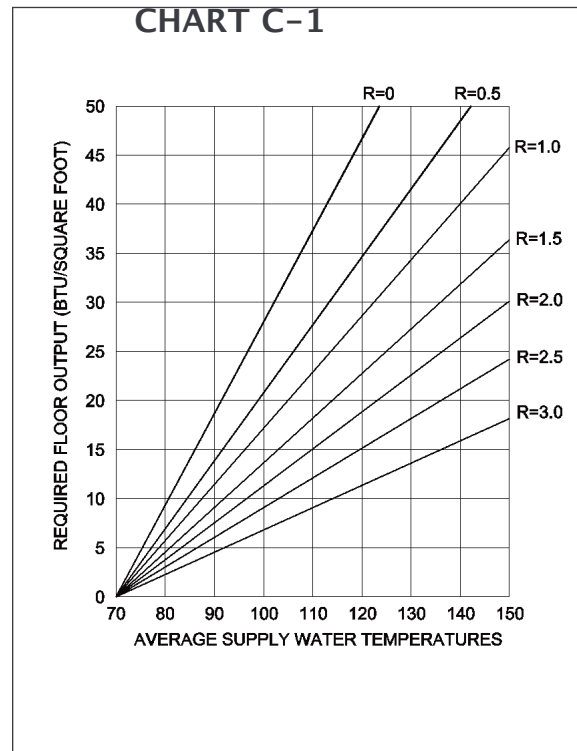

DESIGNER'S NOTE

Learn about the resistance of intended floor coverings at the design stage and make sure they are within the requirements of the system. Realize also that your calculation should include the resistance of the whole flooring assembly above the Infloorboard™. If you are unfamiliar with hydronic design, good practice and the physics of hydronic heat transfer, you should not design a Infloorboard™ system. Consult your Infloorboard™ distributor for assistance and referral to third party design services.

CAD LAYOUT AND DESIGN SERVICES

Third party services can provide complete system design and CAD layouts for Infloorboard™ installation. Contact your Infloorboard™ distributor for details. The Appendix gives an example of services provided by the National Radiant Design Service. All Infloorboard™ systems should be installed by qualified installers.



CAD layouts are particularly useful for first time installers.

ESTIMATING THE REQUIRED NUMBER OF BOARDS:

For simple and fast installation, it is highly recommended that a full Infloorboard™ layout be used, indicating the precise panel and tubing layout. This can be provided by the National Radiant Design Center (See Design services). A full plan is recommended for the first few jobs. Contact your Infloorboard™ distributor about getting a layout and a design. The following calculations can be used for estimating the required number of boards. For experienced installers, calculate the net square footage of each room and multiply by the following factors: *Straight* – 0.133 *Utility* – 0.028 *Combo End* – 0.028

Example: For a 600 Sq. ft. room, multiplying 600 by 0.133 gives approximately 80 straight boards. Multiplying 600 by 0.028 gives 17 Utility pieces.

Multiplying 600 by 0.028 gives 17 Combo end pieces. It is always recommended that an additional 10% material excess be added to the estimation.

Notice Loop Lengths

•*Notice that loop lengths should never be over 250', for heat loss areas over 25 BTU/Sq.Ft., loop lengths should not be over 200'*

•*Since the tubing is 8" on center, a 250' loop will cover a maximum of 166 Sq.Ft. A 200' loop will cover a maximum of 133 Sq.Ft. Remember to allow for the length to the manifolds.*

TUBING: AND LOOP LENGTHS:

Infloorboard™ is designed for use with 3/8" nominal ASTM F-876 PEX (cross-linked polyethylene), with an average outer diameter measuring 0.5 inch. Loops shall never be over 250 feet including the leaders to the manifolds. For areas with heat loss greater than 25 BTU/Sq.Ft., loops shall never be over 200 ft. This is due to high pressure drops and water velocity, as shown in the following chart C-2* (grayed area over 25 BTU/Sq. Ft). Friction losses in the chart are approximate; actual friction losses depend on fluid viscosity and temperature.

*The shaded area in the 250' loop chart C-2 on the following page indicates a high pressure drop. It is recommended to use the shorter 200' loop length in this case, as shown in

the second chart. Once the room square footage is determined, multiply the total by 1.5. Example: For a 600 Sq.Ft. room, multiplying 600 by 1.5 gives 900 lineal feet of 3/8" PEX tubing. This room would require 4 loops at 225 ft. each. Alternatively, three 250 foot loops and one 150 foot loop could be used, provided that the flow to the different loops is balanced by using, and adjusting correctly, balancing valves on each loop.

INFLOORBOARD™ 250' LOOPS 20°F TEMP DROP•

BTU/SQ/FT	10.00	15.00	20.00	25.00	30.00	35.00	40.00
Friction Loss (Ft. Head)	2.22	4.70	8.01	12.10	16.96	22.80	28.87
Water Speed (Ft./Second)	0.60	0.90	1.20	1.50	1.80	2.10	2.40
GPM Per Loop	0.18	0.27	0.36	0.45	0.54	0.63	0.72

*Shaded areas have high head loss

INFLOORBOARD™ 200 LOOPS 20°F TEMP DROP

BTU/SQ/FT	10.00	15.00	20.00	25.00	30.00	35.00	40.00
Friction Loss (Ft. Head)	0.98	2.07	3.53	5.33	7.47	9.93	12.72
Water Speed (Ft./Second)	0.45	0.68	0.90	1.13	1.35	1.58	1.80
GPM Per Loop	0.14	0.20	0.27	0.34	0.41	0.47	0.54

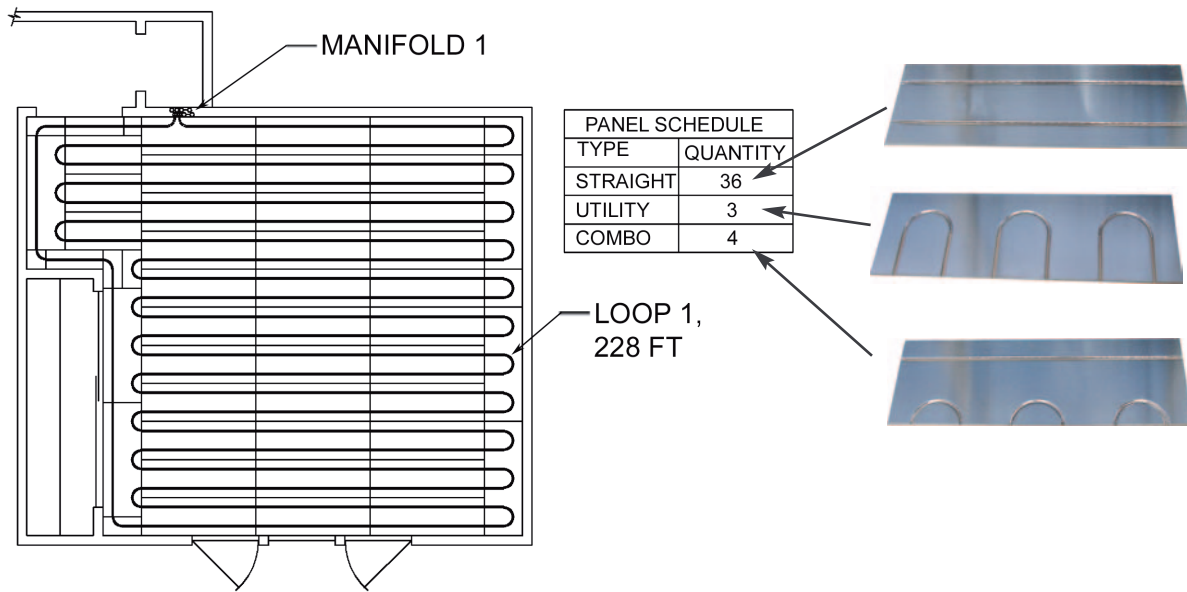

DESIGNER'S NOTE

Remember average water temperature means the average of the supply and return water temperatures flowing to and from the loop. Most typically Infloorboard™ is designed with a 20F° temperature drop. This means the supply water temperature would typically be 10F° higher than the average water temperature.

INSTALLATION

Always Plan Ahead:

- *Carefully read and follow the installation instructions.*
- *Familiarize yourself with the materials and installation methods before you start.*
- *Use and follow a CAD layout, particularly if you are a first time installer.*

UNDERSTAND THE PRODUCT:

COMPONENTS

Infloorboard™ comes in 3 different board configurations. These are “straight”, “utility” and “combo end piece”. They are assembled to make a channel for the pipe. Each piece measures 16” x 48”. The grooves are centered 8” apart. Infloorboards cut easily with a circular saw.

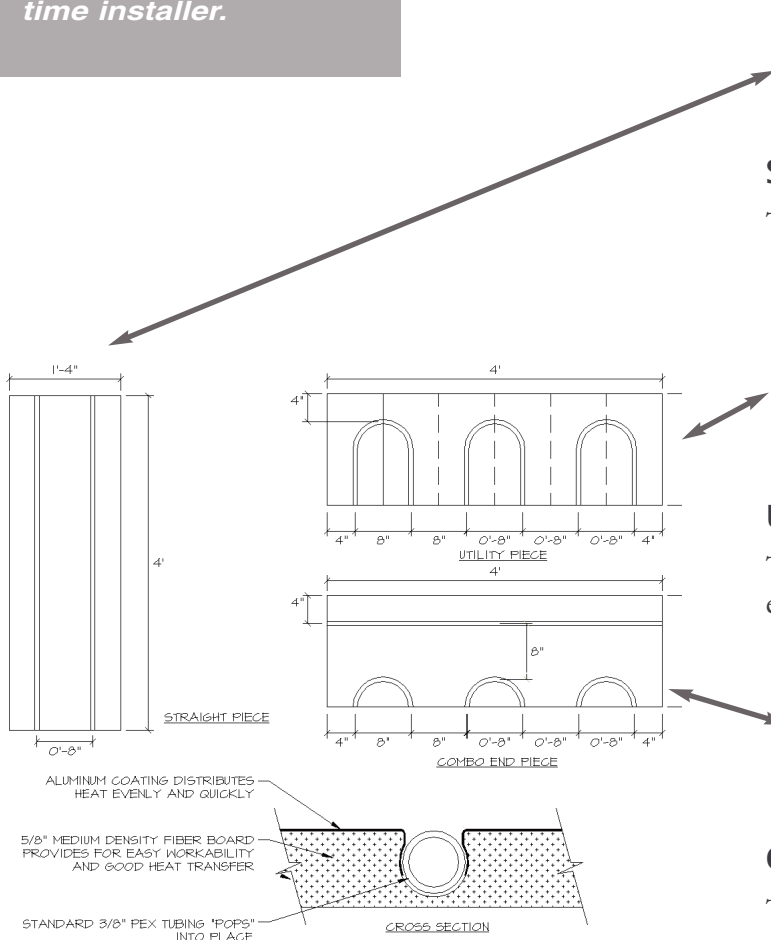

STRAIGHT:

These are used about 70% of the time



UTILITY END:

These are used when only a return is needed, usually about 15% of the time.



COMBO END:

These are used when a return and an extra channel are needed, usually, about 15% of the time.

PRODUCT SHIPPING INFORMATION:

Nominal dimensions: Each board is 16" x 48" x 5/8" thick, or 5.333 square feet a board

Weight: Approximately 2.5 lbs. per square foot, 13.3 lbs. per board

Pallet Size: 4' x 4' x 24" tall (3 Infloorboards to a row, 32 rows high)

Approximate Pallet Weight: 1280 lbs..

Approximate Truckload Quantities: 16,885.44 square feet, or 33 pallets, 42,214 lbs.

Pallet Appearance: Shrink wrapped, corner protected, color coded corners by part #

Recommended Product Mix: Straight 70%, combo end 15%, utility 15%;

allow 10% extra for waste.

INSTRUCTIONS FOR PROPER STORAGE AND MOISTURE CONTACT:

Infloorboard™ should always be stored in a temperate, dry place (40F°-90F°). Avoid prolonged exposure to sunlight. Do not store in a damp location. Be sure to follow all instructions elsewhere in this manual regarding protecting the board from prolonged moisture contact. If these instructions are not followed, expansion of greater magnitude could create undesirable effects.

UNDERSTAND HOW TO SPACE THE BOARDS:

The actual width of each board is 15 7/8", which provides for installing the boards with a slight gap in between boards, to allow for expansion at different temperatures and for normal variances in humidity in a finished home. When aligning straights with the combo ends or utility ends using a piece of tubing, as shown in the following section, a slight gap of approximately 1/16" will naturally occur between the straight boards. This is normal. Try to allow a similar 1/16" inch gap between the ends of all boards, but always make sure all grooves align, as described in the following section.

INSTALLER'S NOTE: MAKE SURE CUT BOARDS ARE ACCURATELY CUT

Since Infloorboard™ is a modular system, the boards are manufactured to tight tolerances in groove spacing and squareness of the sides and ends. When cutting Infloorboard™, make sure to cut them squarely and align them carefully so that subsequent pieces will fit correctly. This is not difficult, but attention to this easy step will prevent major problems.

HOW TO ALIGN THE GROOVES CORRECTLY:

The easiest way to assure the grooves for the pipe are correctly aligned between boards is to cut 6" pieces of 3/8" ASTM F-876 PEX and use them as alignment tools. To do this, get the boards close to the desired alignment and press a piece of tubing in each groove, lapping 3" into the groove of each board, as shown below. After the board is attached, these should be removed.

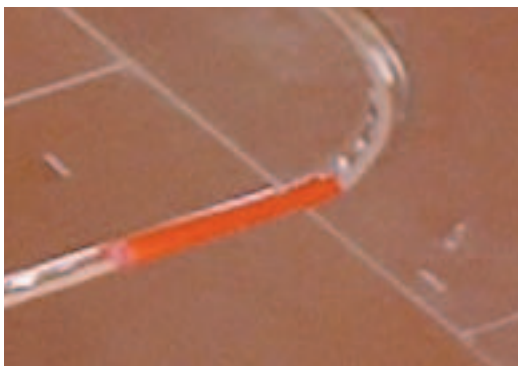

ATTACHING INFLOORBOARD™ TO A SUBFLOOR:

GLUING PATTERNS:

Each Infloorboard™ should be glued to a wooden subfloor using construction adhesive type glue at a minimum 1/8" bead in the gluing pattern below. Every board should be glued.

GLUING PATTERN FOR INFLOORBOARD™ BOARDS

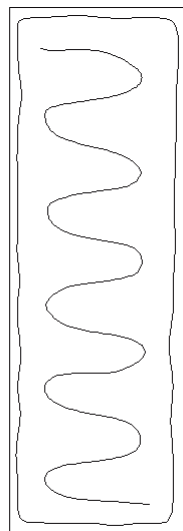

Tips For Gluing

The glue may be applied to the underside of the board or to the floor. Avoid getting glue in the groove or where it may come in contact with the tubing. Many glues can damage PEX tubing.



AFTER GLUING, SCREW OR CROSS STAPLE BOARDS TO SUBFLOOR:

After you have glued the Infloorboards, the boards should be screwed to the subfloor. On full size pieces (16"x48"), ten screws should be used, 8 on the perimeter and 2 in the middle, or as a general rule, 16" O.C. for the perimeter and 24" O.C. for the interior. This pattern is shown below. As an alternative to gluing and screwing, Infloorboard™ may be installed by gluing and stapling, as shown below. When installed with this method, it is very important that the board is glued and stapled with the same quantity of glue and staple points as shown in the screwing pattern. The boards should also be cross stapled as shown for extra strength. Cross stapling means 2 staples are put closely together at opposing 45° angles, as shown below.

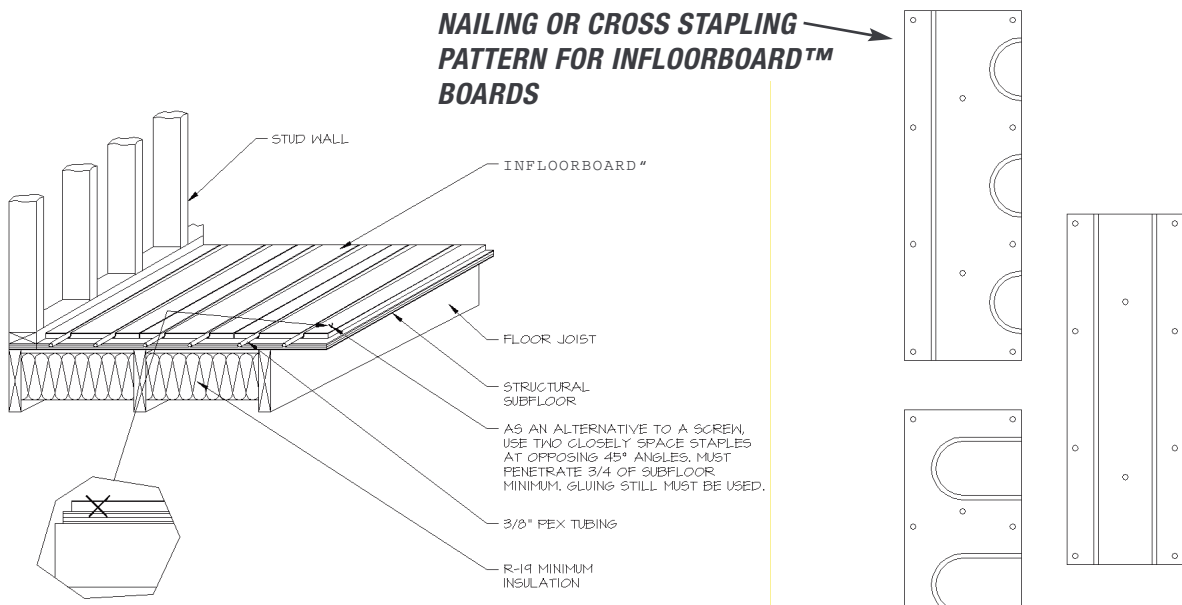

CROSS STAPLING INFLOORBOARD™ BOARDS



SCREWING INFLOORBOARD™ BOARDS

OVERVIEW OF FLOOR SURFACE REQUIREMENTS:

Note: See also the specific application drawings and notes for installing Infloorboard™, on pages that follow in this manual.

SUBFLOOR REQUIREMENTS GENERAL:

The surface of the subfloor must be flat: The requirement for flatness is defined as the maximum difference between two adjacent high points and the intermediate low point. The maximum acceptable difference in level is 3/16 of an inch in a 10-ft. radius.

Fill excessive voids or low areas using a leveling compound: Allow the leveling compound to dry thoroughly before beginning the installation. Check with the leveling compound manufacturer to be sure it is appropriate for the application. High areas can be ground down or floated over with a self-leveling compound. The surface of the floor must be clean and dry.

SUBFLOOR REQUIREMENTS, WOOD SUBFLOORS:

Wood subfloors must have a stable moisture content, between 6 – 10%. Creaking subfloors must be repaired before installation. If the subfloor sags, inspect the joists below for twists or weakness. If the subfloor is cupped or uneven at the joints, recheck the moisture content of the subfloor to be sure it is in the 6 – 10% range. Check for excessive moisture in the crawl space or basement and look for other signs of a potential water problem. High areas are sanded or planed; low areas are patched or filled with an appropriate leveling compound, or covered with a rigid underlayment. When using a leveling compound, be sure to follow the manufacturer's recommendations, and allow the compound to dry completely before starting to install the floor.

IMPORTANT NOTE: INFLOORBOARD™ AND CONCRETE SUBFLOORS:

Infloorboard™ was designed to be installed over a wooden subfloor. Installation over concrete has been successfully done, but requires extreme care, an assured dry slab and is not a preferred application. Details for installation over concrete are available upon request. A future product, Infloorboard™ II, will be specifically designed to be able to float over a concrete subfloor, and for the systematic application of a vapor barrier.

EQUIPMENT REQUIRED FOR INSTALLATION OVER WOODEN SUBFLOOR:

The following is necessary for the installation of Infloorboard™:

- Table or circular saw. A carbide blade is recommended.
- Electric or cordless drill gun with No. 2 Phillips bit (if you are screwing down boards) and 5/8" drill bit for supply and return bury points
- Sheathing type pneumatic stapler (if you are cross stapling boards)
- Rubber or hard hide mallet
- Chalk line, marking pencils and square
- Vacuum cleaner to clean grooves prior to installation
- 6" pieces of 3/8" PEX for alignment of grooves
- Tubing uncoiler is recommended for installing tubing

INSTALLERS NOTE: CUTTING INFLOORBOARD™

Infloorboard™ cuts easily with a quality carbide circular saw blade. Pieces frequently must be cut to provide an accurate fit for each room. It is important that they be cut squarely to keep the alignment of grooves accurate in the installation. If you are cutting a large number of boards for a complicated space, number them and make a map so you remember where they go.





INSTALLING TUBING IN THE GROOVES:

First, vacuum the grooves so there is nothing that will damage the tubing or keep it from going properly into the groove. The use of a tubing uncoiler is recommended. Start at the intended manifold location and allow enough tubing as a ‘leader’ to attach the tubing to the manifold. You may then begin, but make sure you understand the layout and where and how you will return to the manifold. There is, intentionally, a tight tolerance between the ASTM F-876 PEX tube and the slightly undercut groove. This allows the tubing to be retained in the grooves once it is pushed in place. Usually, this only requires “walking the tubing into the groove:” as shown in the photographs below. Occasionally tubing installation may require the use of a rubber or hide mallet as shown on the previous page to force the tubing in place in the grooves. After installing a loop of tubing, always walk the loop and make sure the tubing is fully in the groove for the entire length of the groove. This is very important! The top of the tubing should be just below the level of the top of the Infloorboard™, and fully retained in the groove.

INSTALLER’S NOTE: INFLOORBOARD™ WARMCOAT™ METAL AND GROOVES

Infloorboard™ has an aluminum Warmcoat™ metal layer that is slit for the grooves. It is designed to be folded down into the grooves and pressed to the side as the tubing is pushed into the groove.



EXAMPLE LAYOUT AND INSTALLATION:

INSTALLATION STEP 1: Utilizing a plan layout, determine panels needed and tubing lengths required. Be sure to always use good judgement in allowing enough tubing at ends for leaders up to manifolds. A plan should indicate which type of system will be implemented.

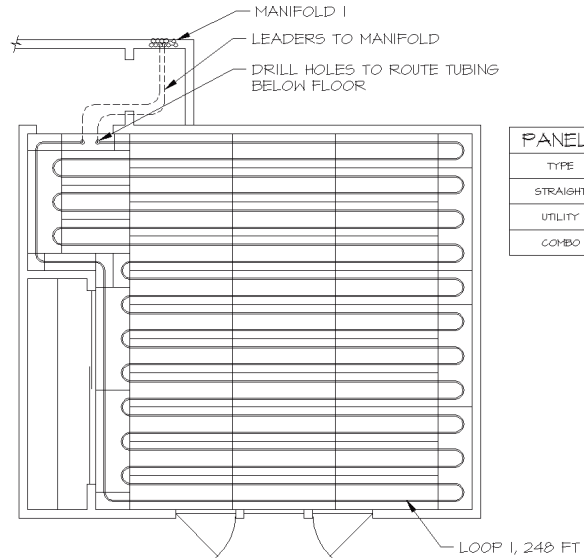

PANEL SCHEDULE	
TYPE	QUANTITY
STRAIGHT	36
UTILITY	3
COMBO	4

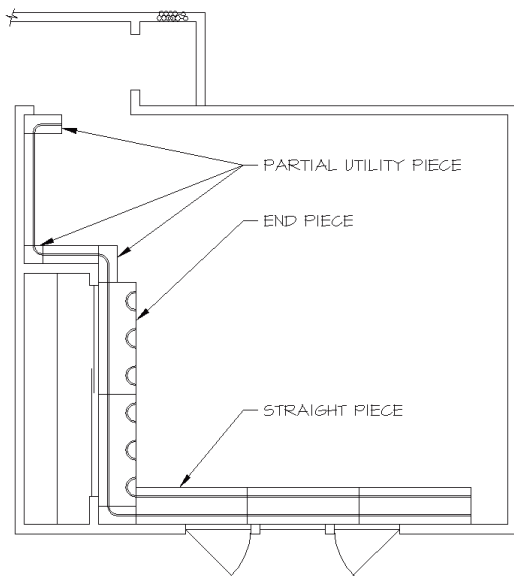

INSTALLATION STEP 2: Begin the Infloorboard™ layout by starting at the beginning of the supply run into the space and running board along the perimeter of the heated space to the area of highest heat loss.

INSTALLATION STEP 3:

Add end pieces and straight pieces, working your way back away from the area of heat loss. Once all boards are in place, drill holes (subfloor with access application) or route leader back to manifold via custom grooves or grout (slab or existing subfloor application) for supply and return leaders to manifolds.

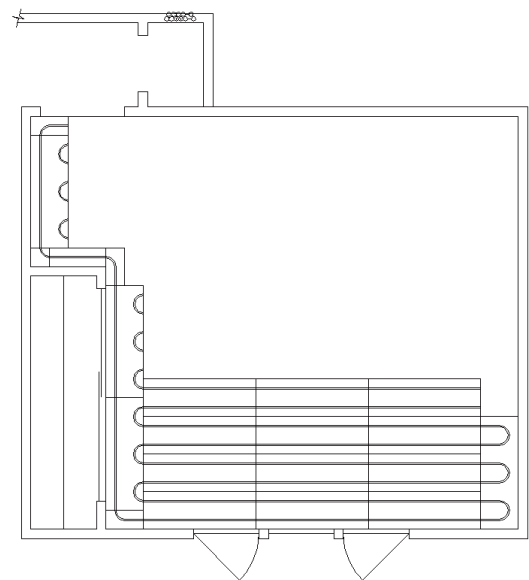

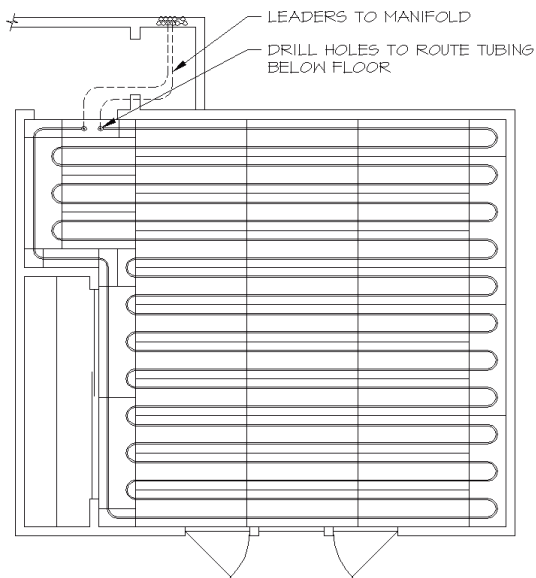

INSTALLATION STEP 4:

Feed enough supply tubing to route to manifold through drilled supply hole below the floor or before the start of groove (if groove goes directly to manifold). Tubing may then be “popped” into grooves after all grooves have been thoroughly cleaned with a vacuum cleaner. Once tubing has been routed back to the return location, cut enough to route to return manifold.



SPECIAL COVERAGE AREAS:

In areas of special coverage, such as shower basins using tile grout as a base, tubing may be routed to and from Infloorboard™ in order to accommodate desired coverage.

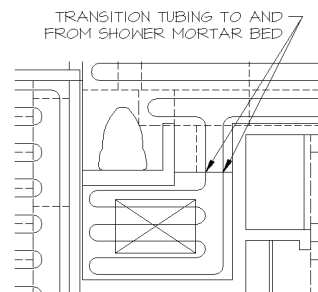

CONNECTIONS AT MANIFOLD:

Manifolds are usually located in a space with an access panel, near the heating zone they serve, in places like in the back of a closet. The tubing may be routed to the manifold in four ways:

- 1) Insert tubing directly in the grooves, which works with few loops ending adjacent to the manifold location.
- 2) Drill holes, dive the tubing under the floor and bring it up again at the manifold.
- 3) Place solid MDF sheet next to the manifold into which supply and return lines are custom routed to the grooves of the Infloorboard™.
- 4) Or, tubing may be run out of the Infloorboard™, stapled to the subfloor and routed directly to the manifold. A grout may then be used to cover the tubing and level it to the Infloorboard™. If needed, spacers are placed in between tubing to provide a nailing or screwing base for floor coverings. Use nailing plates as necessary to protect tubing from damage.

Depending on how many circuits are on a given manifold various sizes of sheets or grouting area are required.

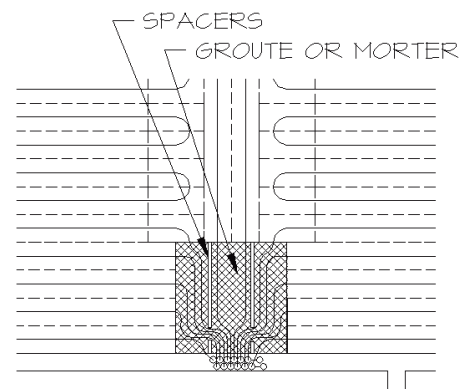
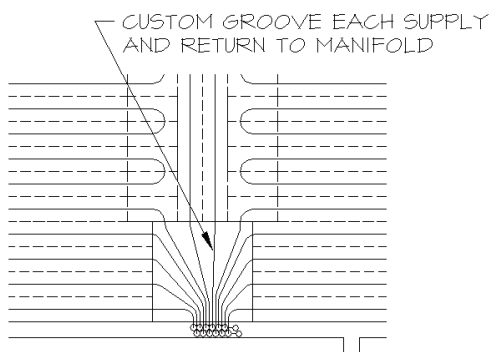

INFLOORBOARD™ INSTALLED OVER WOOD SUBFLOOR

GENERAL INSTALLATION REQUIREMENTS FOR ALL FLOORING OVER WOOD SUBFLOOR

- 1) Do not install Infloorboard™ without an accurate room-by-room heat loss analysis of the structure to be heated and a design/layout for Infloorboard™ that takes into account the resistance and heat transfer of the actual floor coverings. If Infloorboard™ cannot provide all the necessary heat, make provisions for additional back up heat.
- 2) Thoroughly clean all surfaces that Infloorboard™ will be applied to. The surface to which Infloorboard™ will be attached must be flat and dry prior to installation. See requirements for flatness and moisture. The requirement for flatness is defined as the maximum difference between two adjacent high points and the intermediate low point. The maximum acceptable difference in level is 3/16 of an inch in a 10-ft. radius. Wood subfloors must have a stable moisture content between 6 – 10%. Creaking subfloors must be repaired before installation. If the subfloor sags, inspect the joists below for twists or weakness. If the subfloor is cupped or uneven at the joints, recheck the moisture content of the subfloor to be sure it is in the 6 – 10% range. Check for excessive moisture in the crawl space or basement and look for other signs of a potential water problem. High areas should be sanded or planed, low areas patched or filled with an appropriate leveling compound, or covered with a rigid underlayment. When using a leveling compound, be sure to follow the manufacturer's recommendations, and allow the compound to dry completely before starting to install the floor.
- 3) Chalk lines of a square reference point, as walls may out of square.
- 4) Lay out boards according to the plan.
- 5) Secure boards with construction adhesive to the wooden subfloor. Be sure to use adequate adhesive and follow the recommended pattern.
- 6) Start layout of all pieces by securing a corner to allow for proper alignment.
- 6) Use 6" lengths of tubing in the grooves, lapping 3" into each board to help align the grooves of the boards.
- 7) A 1/16" width space shall be used between boards.
- 8) After gluing boards in place, drill and screw or cross staple Infloorboards to subfloor, according to recommended pattern.
- 9) Once all boards are installed, clean out all grooves with a vacuum.
- 10) Snap tubing into groove and route to manifold per plan.
- 11) Follow specific extra recommendations for each floor covering, and refer to the complete installation manual for further instructions on the installation of the Infloorboard™ system.

CARPET OVER INFLOORBOARD™

Infloorboard™ shall be installed over a wooden subfloor, complying with “General Infloorboard™ Installation Requirements For All Flooring Over Wood Subfloor”. In addition, the following specific cautions and instructions shall be followed:

Carpet and pad may be installed over Infloorboard™. When installing the pad, care should be taken to avoid puncturing tubing. It is advised that a thin layer of underlayment plywood be applied over Infloorboard™ prior to carpet and pad installation to protect tubing from point loads. As with all radiant heating installations, a thin slab foam rubber pad and short, high density carpet should be used. If carpet pad is glued, a high temperature latex adhesive must be applied. Glue to underlayment plywood: do not glue to Infloorboard™ or to tubing! Maintain 2” minimum tubing clearance from carpet tack strips.

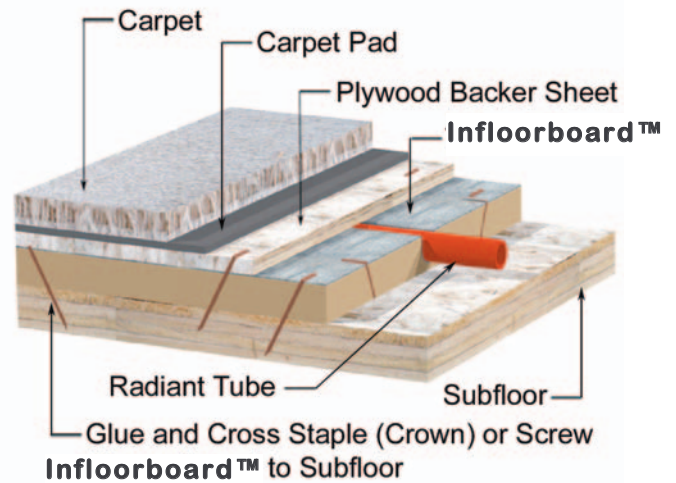
**VINYL OVER INFLOORBOARD™**

Infloorboard™ shall be installed over a wooden subfloor, complying with “General Infloorboard™ Installation Requirements For All Flooring Over Wood Subfloor”. In addition, the following specific cautions and instructions shall be followed:

When installing vinyl flooring, it is required that a thin layer of underlayment plywood be applied over Infloorboard™. In wet locations, a sealant layer should be added. Underlayment plywood that has a grid printed on it helps locate tubing runs and prevent puncturing the tubing when the plywood is being screwed to the Infloorboard™. In the case of vinyl, use underlayment, filler and glues suggested by the manufacturer for use over radiant heat. Most vinyl flooring is manufactured to an ASTM standard with an upper limit of floor temperatures of 85°F. This limit should be followed. Attach required underlayment with care to not puncture tubing.

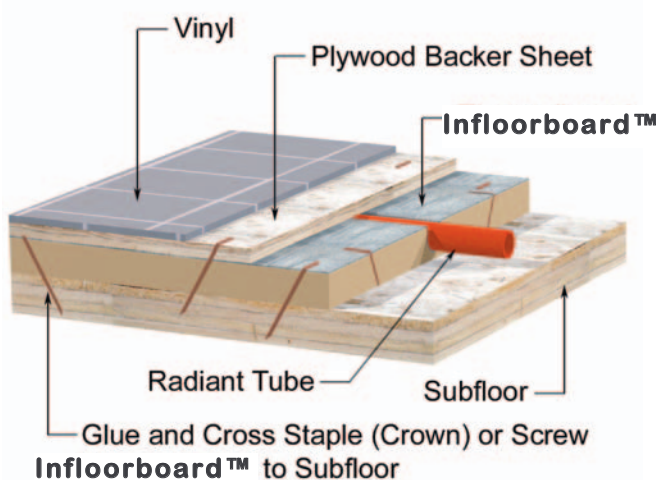

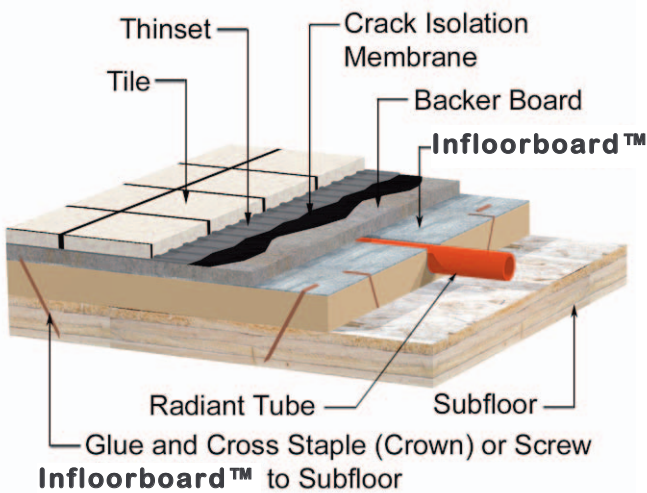

Thinset Tile or Stone for areas unlikely to be subject to moisture

INSTALLER'S CAUTION:

Do not omit the backerboard layer. Do not thinset directly to Infloorboard™, the aluminum will not provide a good bond. Do not install crack isolation membranes directly to Infloorboard™, they will not get a good bond and many of them use materials that are incompatible for contact with Pex pipe.

THINSET TILE OR STONE OVER INFLOORBOARD™:

Infloorboard™ shall be installed over a wooden subfloor, complying with “General Infloorboard™ Installation Requirements For All Flooring Over Wood Subfloor”. In addition, the following specific cautions and instructions shall be followed:
 When installing masonry, tile and stone, backer board shall be used over Infloorboard™. Thin set installation shall then be used. In the kitchen, baths, laundry or any other area where water may be present, water sealant layer (i.e. Nobleseal) shall be used. Where tile or stone is going to be thinset, anti-fracture membrane (Nobleseal) or equivalent shall be installed over the backerboard. Maintain 2” minimum tubing clearance when screwing backer board down. Refer to the complete installation manual for further instructions on the installation of the Infloorboard™ system.

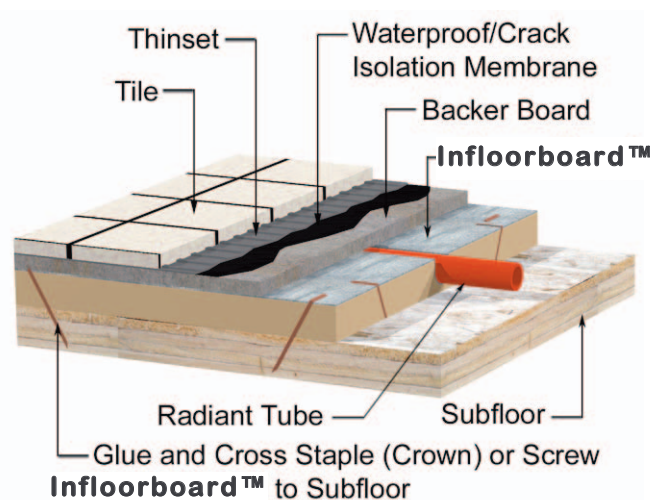

Thinset Tile or Stone for areas likely to be subject to moisture

Notes On Sealing

The aluminum layer on the top of each Infloorboard™ is highly water resistant. Thus a significant degree of moisture protection can be given to the board simply by using silicon sealant as a caulk between the boards. Properly applied, this will profoundly reduce the likelihood of water transmission into the boards. This is not a substitute for recommended installation methods in wet areas.

MORTAR BED SETTING OF TILE OR STONE OVER INFLOORBOARD™:

Infloorboard™ shall be installed over a wooden subfloor, complying with “General Infloorboard™ Installation Requirements For All Flooring Over Wood Subfloor”. In addition, the following specific cautions and instructions shall be followed: When installing masonry, tile and stone, backer board shall be used over Infloorboard™. A conventional mortar bed shall then be used. In the kitchen, bath, laundry or any other area where water may be present, a water sealant (i.e. Nobleseal) shall be used. Maintain 2” minimum tubing clearance when screwing backer board down. Refer to the complete installation manual for further instructions on the installation of the Infloorboard™ system.

Traditional mortar set tile or stone for areas unlikely to be subject to moisture

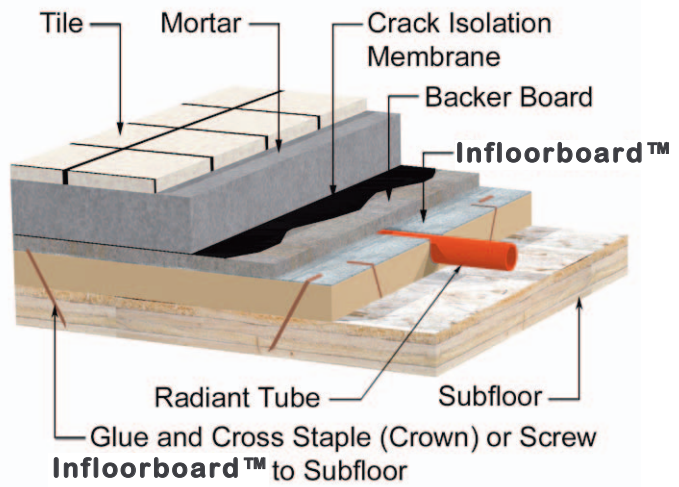

INSTALLER'S CAUTION:

Do not omit the backerboard layer. Do not set directly to Infloorboard™, the aluminum will not provide a good bond. Do not install crack isolation membranes directly to Infloorboard™, they will not get a good bond and many of them use materials that are incompatible for contact with Pex pipe.

Traditional mortar set tile or stone for areas likely to be subject to moisture

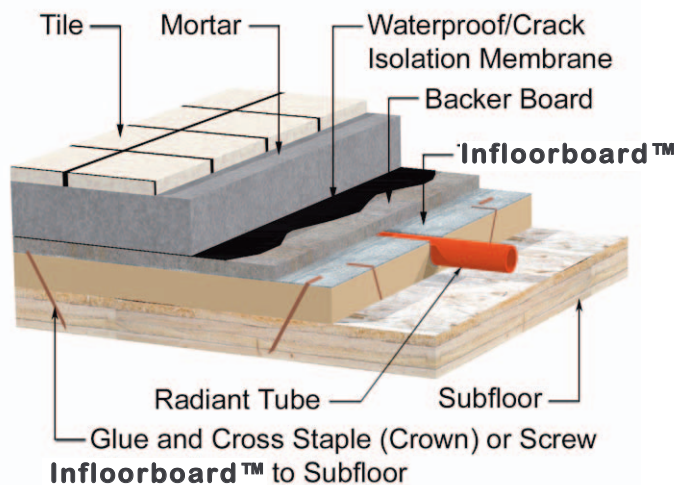

Notes On Sealing

The aluminum layer on the top of each Infloorboard™ is highly water resistant. Thus a significant degree of moisture protection can be given to the board simply by using silicon sealant as a caulk between the boards. Properly applied, this will profoundly reduce the likelihood of water transmission into the boards. This is not a substitute for recommended installation methods in wet areas.

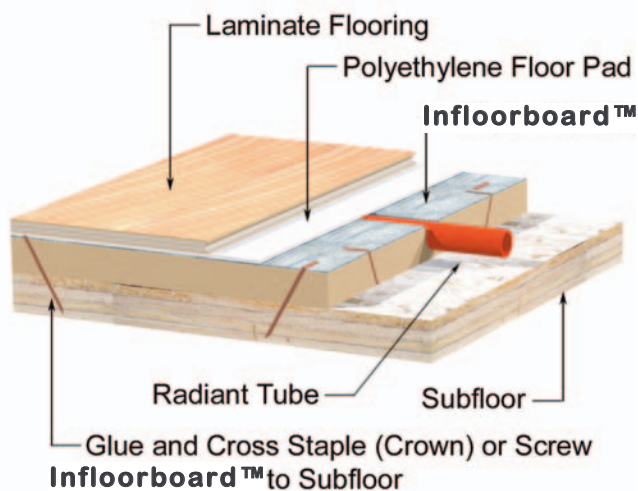

LAMINATE OVER INFLOORBOARD™

Infloorboard™ shall be installed over a wooden subfloor, complying with “General Infloorboard™ Installation Requirements For All Flooring Over Wood Subfloor”. In addition, the following specific cautions and instructions shall be followed:

When installing laminate flooring, it is advised that a thin layer of underlayment plywood shall be applied over Infloorboard™. In wet locations a sealant layer should be added over the underlayment layer of plywood. Many, but not all, laminate flooring products

are suitable and recommended by the manufacturer for use with radiant floor heat. Check before installing. Many laminate flooring products have floor temperature limits that need to be observed as well. Install laminate flooring crosswise to Infloorboard™ whenever possible. It is recommended that laminate flooring installed over Infloorboard™ shall employ controls that gradually adjust water temperature going to the Infloorboard™ with a reset curve. A floor temperature limiting sensor can be used to comply with flooring manufacturer’s flooring temperature specifications.

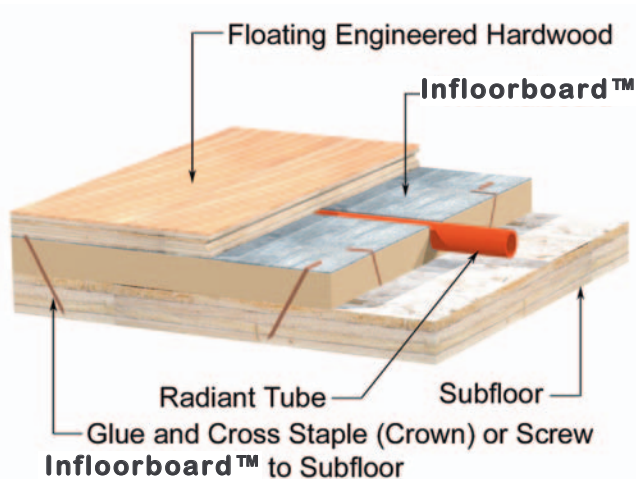

ENGINEERED WOOD OVER INFLOORBOARD™

Infloorboard™ shall be installed over a wooden subfloor, complying with “General Infloorboard™ Installation Requirements For All Flooring Over Wood Subfloor”. In addition, the following specific cautions and instructions shall be followed:

Many, but not all, engineered wood flooring products are suitable and recommended by the manufacturer for use with radiant floor heat. Check before installing. Many engineered wood flooring products have floor temperature

limits that need to be observed as well. Install engineered wood flooring crosswise to Infloorboard™ whenever possible. It is recommended that engineered wood flooring installed over Infloorboard™ shall employ controls that gradually adjust water temperature going to the Infloorboard™ with a reset curve. A floor temperature limiting sensor can be used to comply with flooring manufacturer’s flooring temperature specifications.

TRADITIONAL HARDWOOD INSTALLED DIRECTLY OVER INFLOORBOARD™

A conventional nailed and hardwood type system may be used directly over Infloorboard™, with nailing long enough to penetrate the subfloor, and with the utilization of recommended controls. See also sections on general considerations with the use of traditional wood flooring. Infloorboard™ shall be installed over a wooden subfloor, complying with “General Infloorboard™

Installation Requirements For All Flooring Over Wood Subfloor”. In

addition, the following specific cautions and instructions shall be followed:

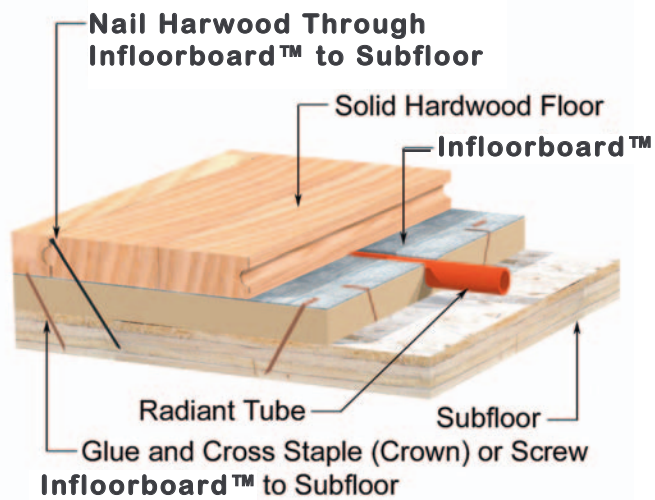

- 1) Care shall be taken to avoid nailing tubing.
- 2) Hardwood floor joints shall not be installed directly at the Infloorboard™ joint.
- 3) Hardwood floor nails shall be long enough to penetrate both hardwood and subfloor.
- 4) Hardwood floors installed directly over Infloorboard™ shall employ controls with a reset curve, that gradually adjust water temperature going to the Infloorboard™; the floor will expand and contract gradually with temperature changes. This will reduce the likelihood of warpage, gapping or shrinkage problems. The use of a floor temperature limiting sensor is recommended.
- 5) It is extremely important that the designer know which way it is desired that the strip flooring be aligned prior to the design of the Infloorboard™ system, since the direction of the Infloorboard™ should run perpendicular to the direction of the strip flooring.
- 6) Install strip flooring with mallet driven nails and nails penetrating the Infloorboard™ 1/2” into the subfloor. Use 15 gauge nails (2.5” with 3/4” floors) to penetrate the subfloor. A nailer such as the Senco # SFM40, with a tongue and groove attachment such as # SFM40 TG, should be used.
- 7) Structure humidity shall be kept within the range specified by the flooring manufacturer.
- 8) The wood flooring shall be installed at the relative humidity recommended by the manufacturer for the climate involved.
- 9) Use narrower 2”-3 1/2” strips of wood flooring over radiant floors.
- 10) The lessons of local practice and climate shall be referenced
- 11) Make sure the heating system has been running and the space has been maintained at least 65F° long enough that temperature and humidity have stabilized to predicted future levels.
- 12) The flooring product shall be allowed to acclimatize before installation.
- 13) Use woods known to be dimensionally stable.

CONSIDERATIONS: TRADITIONAL STRIP WOOD FLOORING OVER INFLOORBOARD™

The key to installing wood floors over radiant heat is to give extra care to wood species, wood width and thickness, moisture levels, installation practices, the heat output requirements of your system, and radiant heating control.

BOARD WIDTH: Install narrow board widths, preferably 3 inches or less. Avoid boards wider than 4 inches. Narrow boards provide more gaps for expansion and contraction across a floor; therefore, gaps resulting from natural movement are much less noticeable. The maximum recommended board depth is 3/4 inch. Thicker boards add too much resistance to heat transfer.

DIMENSIONAL STABILITY: Use quarter sawn wood. It's significantly more dimensionally stable than wood that is plain sawn. Pick a wood that's known for its dimensional stability. American cherry, ash, most softwoods and teak fill this bill, and oak is reasonably stable. By contrast, hickory, maple, madronne and American beech are known to be less stable.

AGE & DRYING IN TROPICAL WOODS: If you're importing tropical or exotic woods, pay close attention to the source, age and how the wood has been dried. Tropical wood needs to dry slowly. Quick drying creates stresses that can affect the wood later as it expands and contracts. If your supplier has stored the wood in your region with no problems for one to two years, surprise stress-related problems are much less likely. Though it can be fun to be unique, avoid pioneering the use of a wood where there is little information on its dimensional stability.

MOISTURE: Wood naturally expands and contracts in response to changes in moisture. With this in mind, avoid installing wood flooring during stages like sheet rocking or painting, when significant moisture may be introduced into a structure. Operate the heating system until the humidity in the structure stabilizes to the average level expected for the area in which the wood floor will be installed. Then, allow the wood to acclimatize to this humidity level by "sticking" (usually several weeks) before installation. This will minimize dimensional changes due to moisture. Make sure the wood is dry, since radiant heat itself can be drying. Experienced flooring installers recommend buying wood for radiant at around 6 to 8 percent moisture content. This figure may change some regionally. Use a moisture meter during the construction process, and then use the average of many readings. Remember, the average expected humidity level of a structure is an average of seasonal conditions. So if the structure is expected to average 30 percent humidity in the winter and 50 percent in the summer, the average would be 40 percent. This equates to about a 7.5 percent moisture content in the wood. Most installers consider this average the ideal moisture level at which to install wood flooring. These numbers can vary significantly by region.

SURFACE TEMPERATURE: The maximum surface temperature of a wood floor should be limited to 85°F. Use a control strategy that assures this will not be exceeded and brings the floors through temperature changes gradually.

OTHER APPLICATION OPTIONS –FOR WOOD FLOORS OVER INFLOORBOARD™:

Infloorboard™ may be used under traditional strip wood flooring in several ways. A conventional nailed and hardwood type system may be used directly over Infloorboard™, with nailing long enough to penetrate sub-floor and with controls as described in the previous section. There are many advantages to this method; they include quick response, lower cost of installation, higher heat output due to lower resistance of flooring, and a quality control that brings the flooring through temperature changes gradually and accurately, which also increases comfort.

Optional floating methods for use with traditional strip wood flooring: 2 layers of 1/2-inch plywood may be floated on top of the Infloorboard™ and strip flooring nailed to it, as shown below in a method recommended by the National Wood Flooring Association. This method has the advantage that it allows the wood flooring system to float independently from the Infloorboard™, but has significant disadvantages in that the 1” extra thickness of wood limits the output of the system. For example, two layers of 1/2” plywood with 3/4” of strip oak flooring has an R-value of about R-2.3. This limits the output of the floor at 150° F water temperature to about 26 BTU/Square Foot. A careful heat loss analysis must be done to see if this method will produce enough heat. If not, another method should be chosen or provisions made for backup heat. A hydronic control strategy that gradually adjusts water temperature going to the Infloorboard™ with a reset curve is recommended but not required with this method.

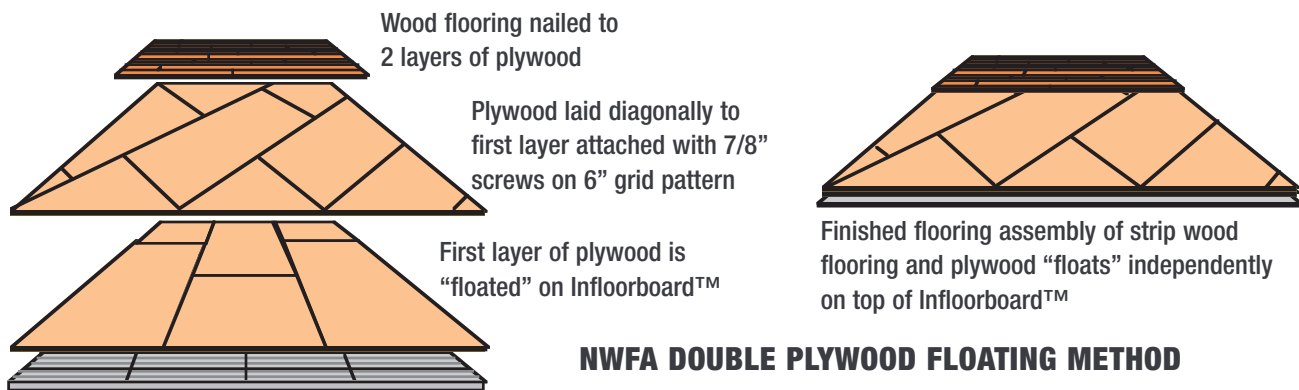

Clip style floating strip flooring systems must be installed directly over Infloorboard™ such that clips will never come in contact with the tubing.

The use of a floating engineered wood is a preferred method. This product should have a specific warranty for use over radiant floors. Many manufacturers of these products have such a warranty, as well as having extensive experience both in Europe and North America with radiant heating applications. Edge glued floating engineered wood flooring systems are preferred, since they are dimensionally stable and expand independently from any thermal mass. Infloorboard™ should be installed such that the hardwood runs perpendicular to the majority of the tubing runs.

Glued down wood flooring systems are not recommended unless a layer of plywood is first screwed down to the Infloorboard™ and the wood is attached to the plywood according to the flooring manufacturer’s recommendations for installation over radiant heat.

APPLICATION OF INFLOORBOARD™ TO WALLS OR CEILING

Infloorboard™ may be installed on walls or ceilings as extra heat output areas when the floors cannot provide all the necessary heat. Radiant walls and ceilings may also be used to provide all the heat of a room in certain circumstances when properly designed. The heat output of radiant walls and ceilings is different from floors, due to differences in the strength of the convective component of the heat which is stronger in radiant floor heating than in walls or ceilings. However, since walls and ceilings are typically covered only with the relatively low r-value of 1/2" of sheet rock, and acceptable surface temperatures are higher, the heat output of these systems can be quite substantial. It is very important not to overheat sheetrock or discoloration or damage may occur. For design purposes, use chart C-1 but correct the output in BTU's downward 5% for walls and 10% for ceilings. This is because the convective component of the heat output is lower in wall and ceiling radiant heating systems.

Infloorboard™ wall and ceiling systems shall be installed as follows:

Infloorboard™ shall be installed square to framing, screwed to studs, rafters and/or blocking with as many joints as possible screwed securely to the framing. Infloorboard™ shall be secured to framing on both sides of the grooves on every board. Layout of all pieces shall be started by securing a corner to allow for proper alignment. 6" lengths of tubing shall be temporarily placed in the grooves lapping 3" into each board to help align the grooves of the boards during installation. Once all boards are installed, all grooves shall be cleaned out with a vacuum just prior to tubing installation. Tubing shall be snapped into the groove and routed to manifold per the plan. A 1" minimum tubing clearance from tubing shall be maintained for all nailing. Add steel plate protectors over tubing where tubing crosses studs. Water temperatures shall not exceed 120F° supply water temperatures when Infloorboard™ is installed under plaster or sheetrock.

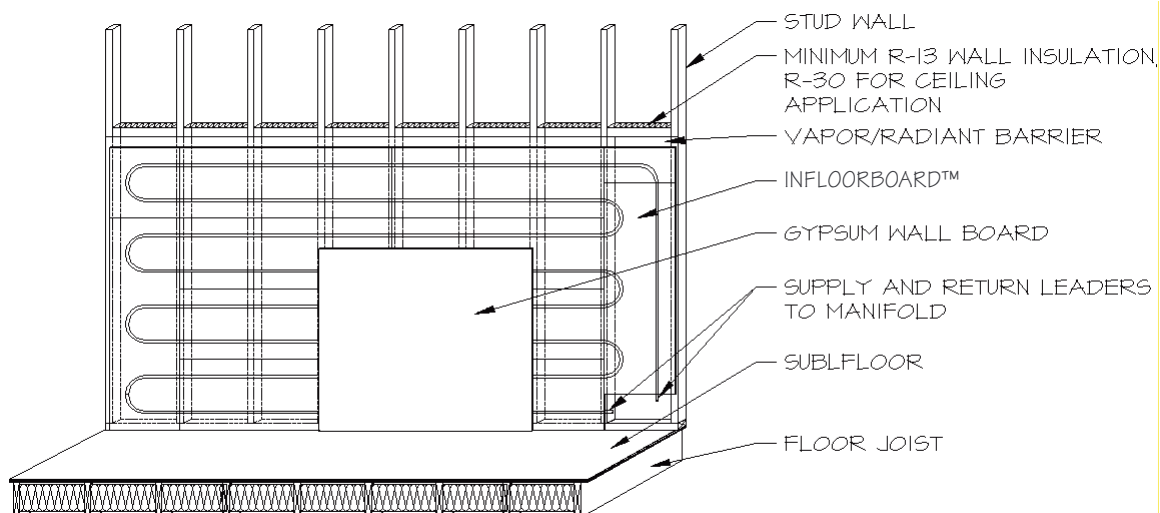

INSTALLING INFLOORBOARD™ OVER CONCRETE

While successful installations of Infloorboard™ over concrete have been done it is not a preferred application due to the difficulties of sealing concrete and attaching Infloorboard™ to concrete.

All concrete slabs give off supplementary moisture whether above, on, or below grade. This can cause problems for any board product installed over it, including Infloorboard™. A different product, InfloorboardII™, is being developed specifically to float over concrete and allow for an easy installation of a continuous vapor barrier. *Infloorboard™ may be installed over concrete using the following methods only when the installing parties are willing to assume full responsibility for the installation and all issues regarding moisture and attachment of Infloorboard™ to concrete.* When installing Infloorboard™ over concrete, the following considerations must be carefully addressed:

It is strongly recommended that all slabs below grade and slabs on grade be sealed against moisture penetration before installing Infloorboard™. A product such as Hydroment Ultraseal may be used. Infloorboard™ is then glued down using wood flooring adhesive rated for use with radiant floor temperatures. Remember that while a slab may appear to be, or actually be, dry during one time of year, this may change as environmental conditions change. Below is a procedure for testing the moisture of above grade slabs, such as between floors in commercial construction. It is the contractor's, as well as the installer's responsibility to test all concrete substrates, both new and old, for moisture content to determine they are sufficiently dry to install Infloorboard™. Moisture in the concrete should be tested according to ASTM F 1869 (Calcium Chloride Moisture Test using the Quantitative Method). With a calcium chloride test, the maximum acceptable reading is 3 lbs./ 4 hours/ 1,000 Sq. ft. New concrete slabs and basements must be cured for a minimum of 60 days prior to installation. Determine that the existing or new slab is sufficiently dry, and do the sealing of the slab before you proceed with any Infloorboard™ installation.

Recommendations for floor coverings installed over Infloorboard™ that is installed on concrete: For masonry tile and stone flooring it is recommended that backerboard be used over Infloorboard™. Conventional mortar bed or thin set installation may then be used as shown in the details. For vinyl, resilient flooring and carpeting it is recommended that 1/4" underlayment plywood be installed on the Infloorboard™ before the finish flooring. Carpet pad should avoid being stapled due to tubing being obscured. As with all radiant heating installations, a thin conductive rubber pad and short, high density carpet should be used. Use of vinyl floors and associated adhesives and materials should be checked for temperature limitations. Conventional and floating type wood floor systems may be used directly over Infloorboard™. Floating laminated wood floors are preferred. Traditional strip wood floors require that 3/4" T&G plywood is first glued to the slab and then Infloorboard™ be installed on the plywood. The tubing is visible when installed in Infloorboard™, so hardwood may be carefully directly nailed to Infloorboard™ or floating methods may be used as shown elsewhere in this manual. See additional notes on installing wood floors elsewhere in this manual. Infloorboard™ should be installed such that the hardwood runs perpendicular to the majority of the tubing runs. For details of installation of flooring materials above the Infloorboard™ layer, refer to the details on the previous pages for additional information and requirements, but refer to the following pages for details of how to install Infloorboard™ itself over concrete. So for example tile would be installed over Infloorboard™ with a backerboard layer, crack isolation membrane, mortar, etc as shown on previous pages, but the Infloorboard™ itself should be installed as shown on the following pages.

INFLOORBOARD™ APPLICATION OVER CONCRETE, WHEN USING ALL REGULAR FLOORING GOODS EXCEPT STRIP WOOD FLOORING:

INSTALLATION OVER CONCRETE:

Installing parties must accept responsibility for and understand all cautions on page 30 regarding moisture and attachment of Infloorboard™ to concrete and should refer to the complete installation manual for further instructions on the installation of the Infloorboard™ system. Do not install Infloorboard™ without an accurate room-by-room heat loss analysis for the structure to be heated as well as a design/layout for Infloorboard™ that takes into account the resistance and heat transfer of the actual floor coverings. If Infloorboard™ cannot provide all the necessary heat, make provisions for additional backup heat.

- 1) Thoroughly clean and level all surfaces where Infloorboard™ will be applied.
- 2) Seal concrete with a vapor membrane such as Hydroment Ultraseal per manufacturer's guidelines.
- 3) Chalk lines of a square reference point, as construction of walls may be inconsistent
- 4) Lay out boards according to plan.
- 5) Be sure to use adequate adhesive compatible with vapor membrane to glue down the Infloorboard™ to the membrane.
- 6) Start layout of all pieces by securing a corner, to allow for proper alignment.
- 7) Use 6" lengths of tubing in the grooves lapping 3" into each board to help align the grooves of the boards.
- 8) Once all boards are installed, clean out all grooves with a vacuum prior to tubing installation.
- 9) Snap tubing into groove and route to manifold per plan.
- 10) Install backerboard when applying tile or vinyl floor goods.
- 11) Maintain 2" minimum tubing clearance from carpet tack strips or other nailing.
- 12) Refer to previous drawings for additional details and requirement of flooring goods installed over Infloorboard™.

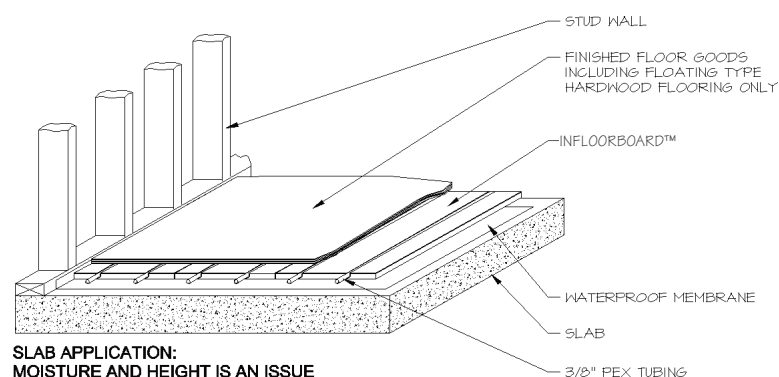

APPLICATION OF INFLOORBOARD OVER CONCRETE, WITH STRIP WOOD FLOORING

INSTALLATION OVER CONCRETE:

Installing parties must accept responsibility for and understand all cautions on page 30 regarding moisture and attachment of Infloorboard™ to concrete, and should refer to the complete installation manual for further instructions on the installation of the Infloorboard™ system. Do not install Infloorboard™ without an accurate room-by-room heat loss for the structure to be heated, as well as a design/layout for Infloorboard™ that takes into account the resistance and heat transfer of the actual floor coverings. If Infloorboard™ cannot provide all the necessary heat, make provisions for additional backup heat.

- 1) Thoroughly clean and level all surfaces that Infloorboard™ will be applied to.
- 2) Seal concrete with a vapor membrane such as Hydroment Ultraseal per manufacturers guidelines.
- 3) Glue T&G 3/4" plywood down to vapor membrane. Be sure to use adequate adhesive compatible with vapor membrane to glue down the plywood to the membrane. Weight the plywood if necessary to make it lie flat
- 4) Chalk lines of a square reference point, as construction of walls may be inconsistent.
- 5) Lay out boards according to plan.
- 6) Glue and screw or staple Infloorboard™ to plywood. Be sure to use adequate adhesive.
- 7) Start layout of all pieces by securing a corner, to allow for proper alignment.
- 8) Use 6" lengths of tubing in the grooves lapping 3" into each board to help align the grooves of the boards.
- 9) Once all boards are installed, clean out all grooves with a vacuum just prior to tubing installation.
- 10) Snap tubing into groove and route to manifold per plan.
- 11) Install strip flooring with mallet driven nails and nails penetrating the Infloorboard™ 1/2" into the plywood. Use 15 gauge nails (2.5" with 3/4" floors) to penetrate into plywood. A nailer such as the Senco # SFM40 with a tongue and groove attachment # SFM40 TG should be used.
- 12) Insulfoam/plywood combination may be used instead of plywood alone in strip flooring provided the plywood layer is at least 5/8" thick (3/4" preferred) and the foam can be successfully bonded with a compatible adhesive to the vapor membrane. The plywood is placed on the foam and ramset to the slab.
- 13) Hardwood floors installed directly over Infloorboard™ shall employ controls that gradually adjust water temperature going to the Infloorboard™ with a reset curve.

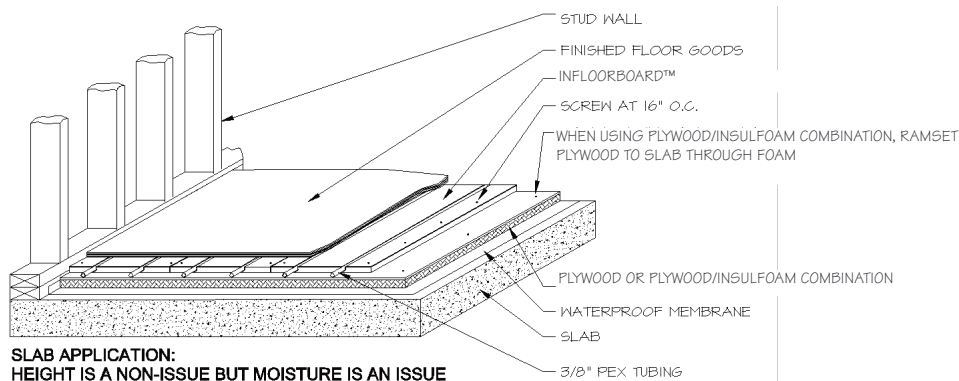

CAUTIONS AND LIMITATIONS OF USE:

GENERAL CAUTION:

As with any radiant heating system, do not install Infloorboard™ without an accurate room-by-room heat loss analysis for the structure to be heated, as well as a design/layout for Infloorboard™ that takes into account the resistance and heat transfer of the actual floor coverings. If Infloorboard™ cannot provide all the necessary heat, make provisions for additional backup heat.

Installer Caution:

This manual is deemed to be current at the time of publication. It is the installer's responsibility to install according to the most current Application Guide. This guide does not purport to address all relevant issues; it assumes a knowledge of good practice in both hydronics and construction methods. Installers should always consult all relevant local, regional and national codes, and adhere to good construction practice. Infloorboard™ should only be installed by knowledgeable, qualified installers. Infloorboard™ installations frequently require the coordination of trades. These are, most typically, mechanical and flooring trades. Any issues regarding this coordination should be worked out in advance. Failure to follow the instructions of this guide, failure to adhere to relevant local, regional and national codes, failure to coordinate trades, and failure to follow good construction practice may cause an unsatisfactory result. See also "limitations of use" elsewhere in this publication. The limitations and instructions of use for PEX pipe and all other hydronic components provided by the manufacturers must also be referenced and followed during installation; this manual does not address many aspects of a hydronic installation.

Limitations of use:

Infloorboard™ is designed for interior use only, and is to be installed only on dry substrata once a structure is closed in, protected from the environment, and will remain dry. Infloorboard™ is not intended as, or rated as, a replacement or substitution for a structural subfloor. The BTU output of Infloorboard™ is limited by the R-values of the finish goods applied over it and by the recommended and available water temperatures. Infloorboard™ is not intended for use with finish goods that are incompatible with the temperatures and conditions present in a radiant heating system. Infloorboard™ is not intended as a finish floor, and should be left uncovered and unprotected only during installation.

INFLOORBOARD™ IS A PATENTED PRODUCT AND IS SOLD UNDER LICENSE FROM WARM BROTHERS INC.

ENERGY CALCS, TUBING AND MECHANICAL LAYOUTS

Professional Infloorboard™ CAD Layouts are provided by:

National Radiant Design Center (NRDC)

227 Forest Avenue, Suite 5 , Pacific Grove, CA 93950

www.designradiant.com (831) 372-7954



Many poor performing heating systems are often the result of improper design due to inaccurate heat loss on a room-by-room basis, which may result in poor performing, undersized or oversized systems. The type of system must be selected based on the level of sophistication and many factors that affect system output such as insulation values, floor coverings, multilevel interaction, floor temperature limitations, heat source type as well as many other factors that go into the design process. All these conditions are used with the aid of computer simulation to maximize efficiency and cost effectiveness of a system. Additionally most radiant heating systems are integrating into a structure in such a manner that they become a permanent part of the building. It is imperative for accuracy and clarity that a proper design be established prior to installation.

Advantages to having a system designed by NRDC are:

Consultation on advantages/disadvantages of different systems

Experience with integrating all types of systems such as solar, geothermal, pool, etc.

Insuring compatibility of different floor coverings to the system type and space heating needs

Experienced recommendations on zoning

Strategic layout of manifolds and tubing based on construction type

Proper specification of heat source and components to fit construction type

A record set for the owner and future owners

Clients can get "apples to apples" bids from prospective installation contractors.

An engineered system can save money, time and headaches

A system design that best matches the construction type and provides strategic zone control

Benefits to the Owner:

As an owner, having NRDC design a system that matches the construction type, you will have piece of mind of having a system work perfectly and with the desired functionality in your new or retrofit application. NRDC works with the client to provide all the options including advantages/disadvantages on various type of systems and will work to match a system that best matches the construction type. With NRDC's expertise, options on different heat sources and controls is presented to allow the customer to make good decisions on their comfort system. When it comes time for installation of a system, using an NRDC plan the owner can get "apples to apples" bids from prospective installation contractors. As a properly designed and installed radiant heating system adds value to the home, a NRDC plan provides a permanent record of the system for resale or for future renovations. With an NRDC designed system, owners can rest easy knowing they will have the most comfortable heating system that can be provided at their budget.

NRDC DESIGN SERVICES, CONTINUED

Benefits to the Architect or Designer:

As is often required by building departments, an NRDC plan may be used as a complete mechanical system than can be incorporated into submittal plans. A “complete heating system design” may be used as a selling feature to client. Having worked on thousands of different types of construction, NRDC can offer expert advice for the integration of the mechanical system into the design as well as advice on which type of system is best suited for different types of construction. NRDC may provide information on integration of the system into the building controls if applicable. Consultation is available on how systems will work with different floor coverings, ceiling heights, window configurations and multi-level, multi-zoned homes and buildings.

Benefits to the Installer:

With a complete NRDC plan, the installation contractor can quickly get material takeoffs for bids. All components including distribution piping are already sized including exact circuit lengths. NRDC provides balancing data for all circuits in a clear concise table. Spend less time fumbling with design aspects and more time getting systems installed. NRDC plans are a good selling feature when speaking to prospective clients as having “plans engineered to ensure proper operation”. With a plan the client will know exactly what they are getting prior to work, which saves time for you and the client in the long run. You will also be providing the owner with a clear, permanent record of the system.

The NRDC Design Advantage:

As a national leader and independent source of design and consultation, NRDC works with homeowners, architects, installation contractors, and manufacturers to design custom or production heating systems for a variety of both residential and commercial buildings. With over 20 years of experience in the radiant industry and having designed over 3,000 systems over much of the US and many parts of the world, NRDC has the experience and knowledge to design a perfect operating system that best matches the type of construction.

A NRDC design – What you get:

- 1. Full size sheets showing plan view of tubing layout including locations of manifolds, heat source and components*
- 2. System balancing data – computer simulation report that summarizes zones, flows, water temperatures, tube lengths which allows the installer to properly bid, install and balance the system for optimal performance.*
- 3. Complete component schematic including specifications on heat sources, pumps, valves, manifolds, expansion tank, etc. and sizing of distribution piping.*
- 4. Installation notes and details*
- 5. System controls page providing controls schemes*

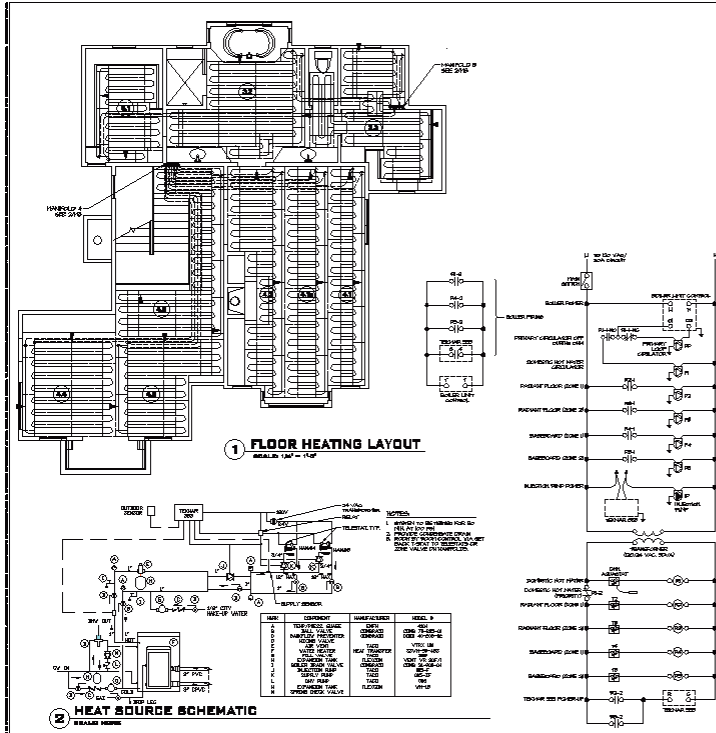

Scaled plan showing exact board and circuit layout with lengths and manifold

System Installation Notes

Computer simulation output showing flow rates, temperature and balancing data

Controls ladder dia -

Mechanical room installation schematic showing arrangement of components including controls and connections heat source.

Application methods for varying types of construction and floors and additional system

REVISIONS

NO.	DATE	DESCRIPTION
1		

NATIONAL RADIANANT DESIGN CENTER
1000 W. 10TH AVENUE, SUITE 1000
DENVER, CO 80202
TEL: 303.733.1111 FAX: 303.733.1112

JOHNSON RESIDENCE
1000 W. 10TH AVENUE, SUITE 1000
DENVER, CO 80202

FLOOR HEATING PLAN

DATE: 1/15/2010
DRAWN: JAC
CHECKED: JAC
SCALE: AS SHOWN

M 1

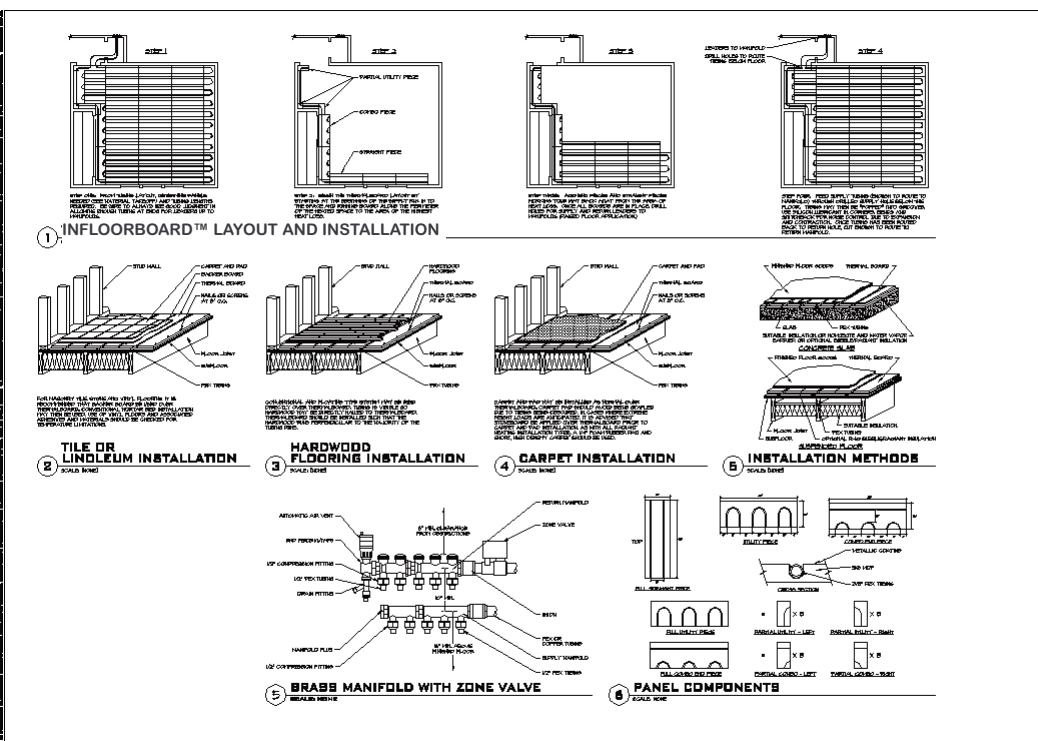

REVISIONS

NO.	DATE	DESCRIPTION
1		

NATIONAL RADIANANT DESIGN CENTER
1000 W. 10TH AVENUE, SUITE 1000
DENVER, CO 80202
TEL: 303.733.1111 FAX: 303.733.1112

JOHNSON RESIDENCE
1000 W. 10TH AVENUE, SUITE 1000
DENVER, CO 80202

FLOOR HEATING PLAN

DATE: 1/15/2010
DRAWN: JAC
CHECKED: JAC
SCALE: AS SHOWN

M 2

DESIGN SERVICES

SAMPLE CAD GENERATED BOARD LAYOUT:

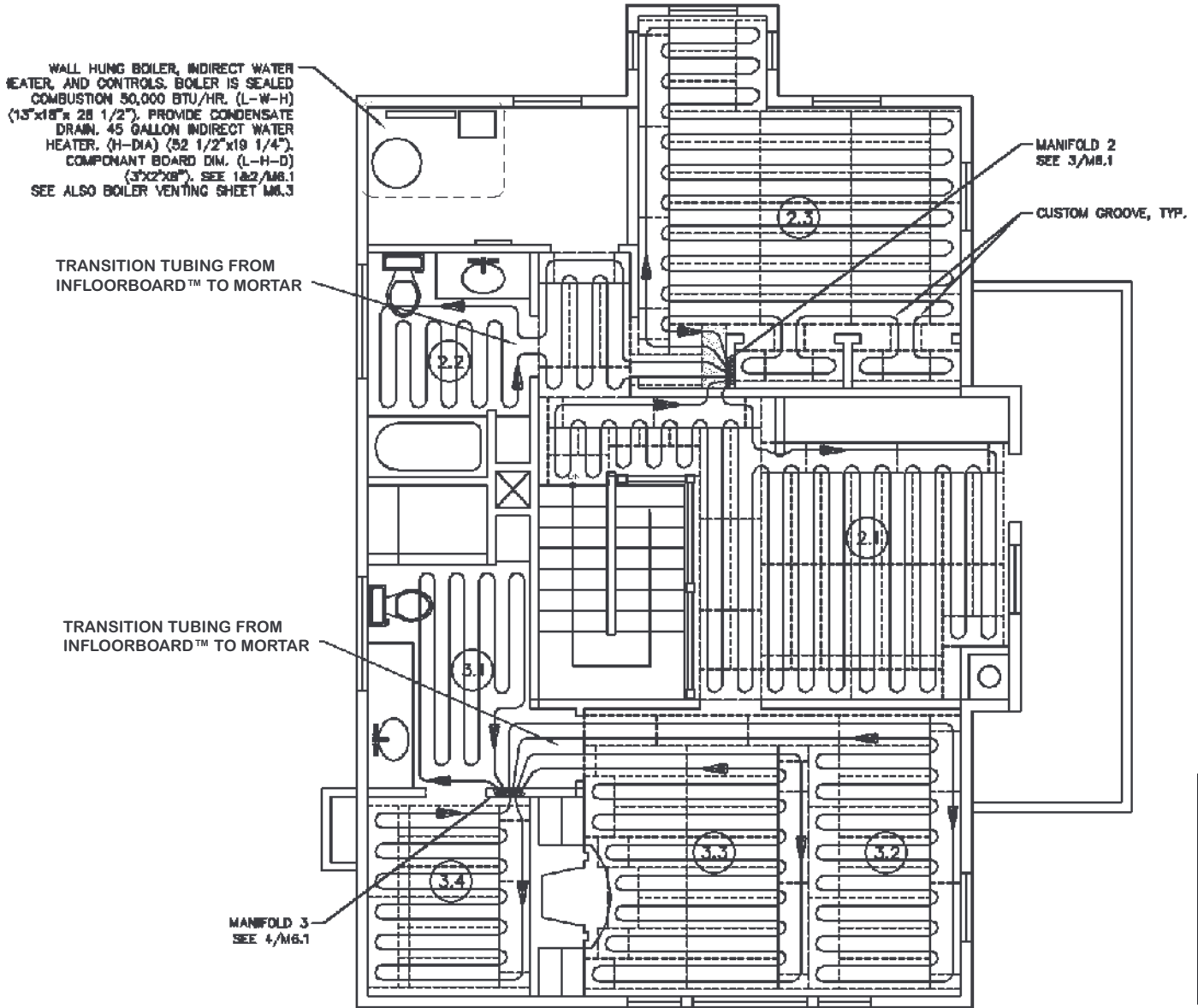

DESIGN SERVICES