



INSTALLATION INSTRUCTIONS FOR DBA-4HPT DRYER EXHAUST BOOSTER

INSTALLATION
AND MAINTENANCE
INSTRUCTIONS

#1579-DBA-4HPT-5-07

READ AND SAVE THESE INSTRUCTIONS

Important Safety Instructions

1. This unit has rotating parts and safety precautions should be exercised during installation, operation and maintenance.
2. **CAUTION:** For General Ventilation Use Only. Do Not Use To Exhaust Hazardous Or Explosive Materials And Vapors.
3. **WARNING: TO REDUCE THE RISK OF FIRE, ELECTRIC SHOCK, OR INJURY TO PERSONS - OBSERVE THE FOLLOWING:**
 - a. Use this unit only in the manner intended by the manufacturer. If you have questions, contact the factory.
 - b. Before servicing or cleaning, unplug power cord or switch power off at service panel and lock service panel to prevent fan from being switched on accidentally. When the service disconnecting means cannot be locked, securely fasten a prominent warning device, such as a tag, to the service panel.
 - c. Installation work and electrical wiring must be done by qualified person(s) in accordance with all applicable codes and standards, including fire-rated construction.
 - d. The combustion airflow needed for safe operation of fuel burning equipment may be affected by this unit's operation. Follow the heating equipment manufacturer's guidelines and safety standards such as those published by the National Fire Protection Association (NFPA), the American Society of Heating, Refrigeration, and Air Conditioning Engineers (ASHRAE) and the local code authorities.
 - e. When cutting or drilling into wall or ceiling, do not damage electrical wires or other hidden utilities.
 - f. Ducted fans must always be vented to the outdoors.

WARNING: If a visual error indicator is activated, do not operate the clothes dryer. See section in this instruction manual titled "Error Indications".

CAUTION: Do not install less than 5 linear feet (1.52 linear meters) from clothes dryer exhaust outlet.

CAUTION: Do not exhaust air in excess of 75°C.

CAUTION: Do not install in an exhaust ductwork of a clothes dryer whose instructions prohibit the installation of a clothes dryer booster fan.

CAUTION: Do not install in an exhaust ductwork where the equivalent duct length is < 25 feet (7.62 meters). The DBA-4HPT is suitable to overcome an equivalent duct length of 130 feet (40 meters) of 4 inch diameter galvanized steel duct, and to maintain a air velocity of 1200fpm (6.10 m/s).

CAUTION: A secondary lint trap must be installed between the clothes dryer and the clothes dryer booster fan if the booster fan is located less than 15 linear feet (4.6 linear meters) from the exhaust of the clothes dryer.

DBA-4HPT Kit Includes:

- 1 A-4HP Inline Fan with Integral Control
- 1 Indicator Panel with 50' (15.4m) of cable
- 1 Fan Mounting Bracket and Hardware
- 1 Duct Clamp
- 1 Tubing & Grommet



Electrical Connection

DO NOT CONNECT POWER SUPPLY UNTIL FAN IS COMPLETELY INSTALLED.

The DBA-4HPT is provided with a 120VAC power cord.

Installation Guidelines

IMPORTANT NOTICE! TO PREVENT THE POSSIBILITY OF DRYER FAN CAVITATION AND/OR EXHAUSTING EXCESS HEAT REQUIRED FOR THE DRYING CYCLE AND COMPROMISING DRYING TIMES, BOOSTER FAN AIRFLOW MUST NOT EXCEED THE DRYER FAN CAPACITY.

Calculating Duct Run

To calculate the length of your planned duct run, measure from the dryer to external venting point in roof or wall. For each bend or elbow add 5-7 feet to your total duct run calculations. The DBA-4HPT can be used on runs up to 130 feet.

Fan and Switch Mounting

The recommended location of the booster fan is a minimum of 15 linear (not equivalent) feet of duct from the dryer outlet. If the fan is mounted closer than the recommended 15 feet, it may develop enough pressure to lift wet lint into the fan impeller resulting in excessive lint loading in the fan. The best location for mounting the fan is as close as possible to the termination of the duct work. *Exception:* If a secondary lint filter is installed between the dryer and the booster fan, the booster fan may be mounted within the minimum distance otherwise recommended (*See illustration on next page*). A mounting bracket (*included*) attached to a rafter or joist should be used to stabilize the fan. Although not recommended, a vertical rigid duct may support the fan if the duct is securely stabilized. (Consult local codes prior to supporting the fan in the duct alone.) The duct work to the inlet of the DBA-4HPT is to be attached with the clamp (*included*) to permit periodic inspection of the blower. Refer to maintenance instructions for inspection recommendations. All duct connections should be properly sealed to prevent leak age and loss of fan performance. Flex duct (if allowed by building codes) should be stretched as smooth as possible.

Indicator Panel

The DBA-4HPT is equipped with a remote mounted low voltage operation indicator panel. This panel contains an LED that will indicate proper operation of the booster fan. In the event of a problem with the system, it will indicate the nature of the problem.

Pressure Sensor Switch Operation

The DBA-4HPT contains a positive pressure sensing switch which recognizes the dryer fan operation and activates the booster fan from an independent electrical circuit. This eliminates connections through the dryer circuit which may void the manufacturers' warranty as well as manual systems which require the attention of the operator or costly current/temperature sensing systems.

Power to the booster fan is provided through the attached 120VAC power cord. A pressure tap is connected to a nipple on the side of the switch. When the dryer begins operation, positive pressure in the duct causes the switch diaphragm to expand closing the circuit to the booster fan.

DBA-4HPT FAN/SWITCH INSTALLATION INSTRUCTIONS

Indicator Panel Installation

Step 1. Selecting Panel Location

The DBA-4HPT indicator panel mounts near the dryer in a location that will be visible to the operator of the dryer. The indicator panel is supplied with 50 feet of cable. Ensure that the indicator panel and booster fan are located to allow their connection with this cable.

Step 2. Wiring and Mounting Panel

The indicator panel is a low voltage device that is not required to be installed in an electrical junction box. If provided with clearance for the cable and terminal block it can be mounted to a wall using appropriate fasteners. If installer chooses to mount indicator panel in a single gang junction box (by others), it should not be installed in a box that contains line voltage wiring or devices. On the end of the 50 foot cable with stripped wires connect red wire to the positive (+) position of the terminal block on the indicator panel. Connect black wire to the negative (-) position of the terminal block on the indicator panel.

Fan Installation

Step 1. Selecting Fan Location

The indicator panel is supplied with 50 feet of cable. Ensure that the indicator panel and boost fan are located to allow their connection with this cable.

Fan **must** be mounted a minimum of 15 feet from the dryer outlet. If the fan is mounted closer than the recommended 15 feet, it may develop enough pressure to lift wet lint into the fan impeller resulting in excessive lint loading in the fan. **Note: See exception on the front page of these instructions.* In any application, the fan should be mounted as close as possible to the termination of the duct work. In order to perform recommended maintenance, fan location should allow sufficient access for service. Refer to dimensional drawings shown on the next page.

NOTE: Steps 2 & 3 may be reversed.

Step 2. Mount Bracket

Using the wood screws provided, attach the mounting bracket to a support beam at the selected location. Bracket is provided with gaskets

in order to isolate any vibration and prevent the transmission of sound through the structure. Be careful not to overtighten.

Step 3. Mount Fan

For proper operation, the control box (located on the fan) needs to be positioned properly. Illustrations on the top of the next page show the correct control box position for fans that are mounted horizontally, vertically and at an angle. The control box should also be positioned to provide access to the indicator panel wiring and the tubing connections. Attach fan to the mounting bracket with the self tapping screws provided. Care should be taken not to strip the housing. Although screw pilot holes are not required, 3/32" (or smaller) pilot holes are recommended.

Step 4. Connect Indicator Panel Cable

Connect the end of the 50 foot cable that has a two position connector to the receptacle located on the dryer booster fan control box.

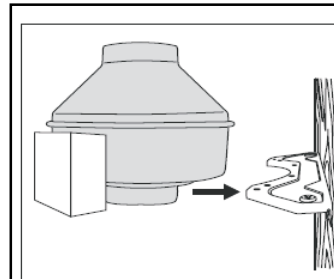
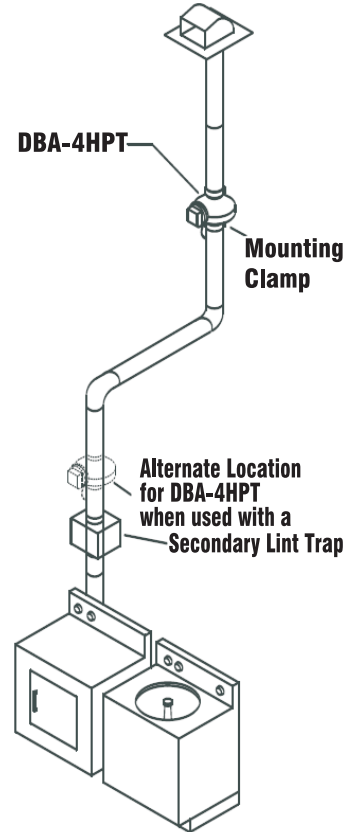

Mount Bracket

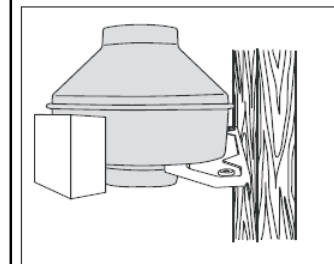

Mount Fan

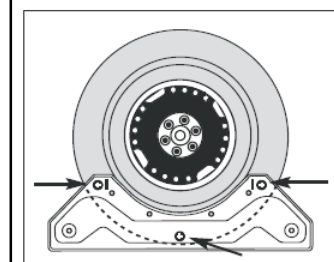

Mounting Bracket and Screw Locations

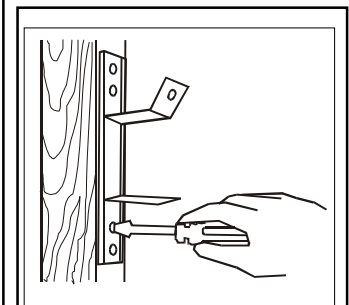

Alternate Bracket

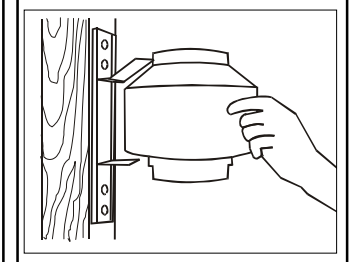

Mount Fan

Pressure Switch Positioning

Correct Switch Positioning-Diaphragm Positioned Vertically

Horizontal Duct

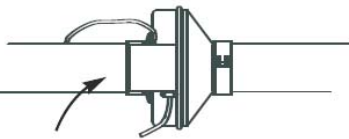

Correct Control Positioning

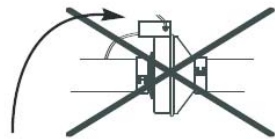

Incorrect Control Positioning

Angled Duct

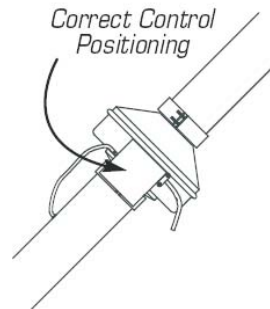

Correct Control Positioning

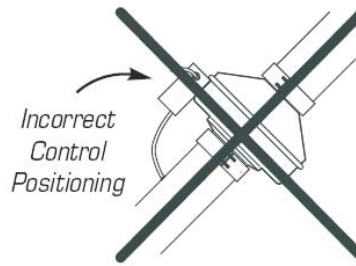

Incorrect Control Positioning

Vertical Duct

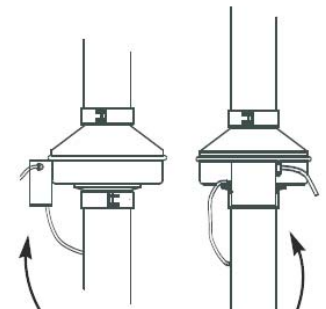

Control Correct in all Positions

Dimensional Data

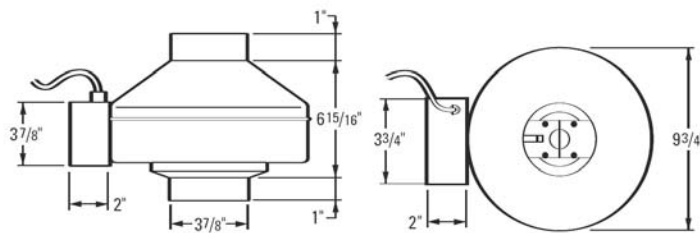

Dimensions in inches.

Step 5. Installing Grommet and Tubing

Do not connect tubing in such a manner as to allow condensation from the duct to collect in the tubing. First, drill a 5/16 inch to 3/8 inch diameter hole in the duct wall. Carefully insert the grommet into the hole. (Drilling a metal duct may produce burrs. Be careful not to be cut or pricked by the burrs or the duct.) Next, force one end of the tubing over the nipple on the control. Make a mark a distance of 1/2 inch from the other end of the tubing. Slide this end of the tubing through the center of the grommet up to the mark as illustrated.

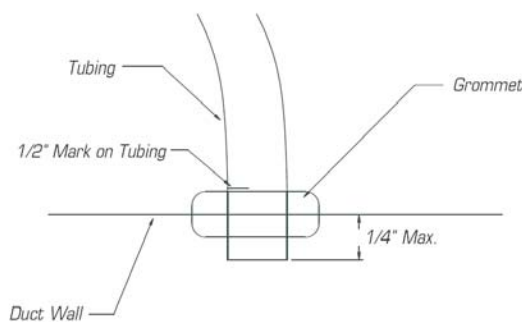

Recommended Maintenance

1. Since fan bearings are sealed and provided with an internal lubricating material, no additional lubrication is necessary.
2. Fan impeller may accumulate lint. Periodic inspection, based on dryer usage should be performed to ensure that the fan impeller is not obstructed or loaded with lint. Under normal conditions, fan should be inspected a minimum of every Six (6) Months. *Note: Excessive booster fan noise or vibration may be an indication of lint buildup on the impeller.*

To inspect and clean the impeller:

- a. Disconnect the incoming power supply at the source.
- b. Remove the duct from the fan inlet and remove any lint buildup on the impeller.
- c. Reconnect the duct to the fan. Turn power supply on.

Troubleshooting

This is a simple procedure to verify proper operation of the booster fan. It should be run at setup to verify that the system is operating correctly. In normal operation the system will indicate the status of the booster fan; however, this process can also be repeated as a system diagnostic.

- a. Generally, if the indicator LED is not illuminated it is OK to run the test. Should you notice any behavior other than that described below, shut the dryer off and wait at least 5 minutes to allow the system to reset and then run the test again.
- b. Start the dryer and run it for a period of 1 minute.
- c. The indicator LED should illuminate about 10 seconds after the dryer starts.
- d. The booster fan it should stop about 30 seconds after the dryer stops.

- e. Indicator LED should remain illuminated until about 1 minute after the dryer stops.
- f. If indicator LED does not illuminate, flashes, or remains illuminated longer than 2 minutes after dryer stops, see error indication section. Otherwise, the booster fan is functioning correctly.

Error Indications

If the LED flashes or does not illuminate, check the list below for error indication and likely sources of the problem. Should your DBA-4HPT show an error other than what is listed, or if these help topics do not solve the problem, please contact **American ALDES** Technical Assistance Department for further assistance. Phone: United States: (800) 255-7749 Email: info@aldes-us.com

1. The LED does not illuminate, check the booster fan operation.

- **If it is not working**,
Verify that the booster fan is properly connected to a 120V AC power source.
- **If it is working**
Verify that the low voltage wire is properly plugged into the booster fan.

Check the polarity of the low voltage connection to the indicator panel (red to positive, black to negative). If the polarity is reversed the LED will not illuminate.

2. LED flashes evenly

This indicates a locked rotor condition. The fan is receiving power, but the motor is not turning. Check the booster fan for obstruction or motor failure.

3. LED flashes twice followed by a brief pause

This indicates that the booster fan is operating at less than its standard speed. Check the boost fan for buildup of debris or motor damage.

4. LED flashes three times followed by a brief pause

- **If the dryer is not running:**
This error indicates a failure to detect the shut down of the dryer. This will not harm the dryer or booster fan in any way, and the light should go out within 5 minutes.

- **If the dryer is running:**
This is indicating that the system airflow has dropped. Check duct system for obstructions.

THREE (3) YEAR WARRANTY

THIS WARRANTY SUPERSEDES ALL PRIOR WARRANTIES

DURING THE ENTIRE WARRANTY PERIOD:

American ALDES will repair or replace any part which has a factory defect in workmanship or material. Product may need to be returned to American ALDES factory, together with a copy of the bill of sale and identified with RMA number.

FOR FACTORY RETURN YOU MUST:

- 1) Have a Return Materials Authorization (RMA) number. This number may be obtained by calling AMERICAN ALDES VENTILATION CORPORATION at 941-351-3441. Please have Bill of Sale available.
- 2) The RMA number must be clearly displayed on the outside of the carton, or delivery will be refused.
- 3) All parts and/or product being returned must be shipped prepaid and be accompanied with a copy of the Bill of Sale.
- 4) Product will be replaced/repared and shipped back to buyer. No credits will be issued.

OR

The Distributor may place an order for the

warranty part and/or product and is invoiced. The Distributor will receive a credit equal to the invoice only after product is returned prepaid and verified to be defective. AMERICAN ALDES WARRANTY TERMS DO NOT PROVIDE FOR REPLACEMENT WITHOUT CHARGE PRIOR TO INSPECTION FOR A DEFECT. REPLACEMENTS ISSUED IN ADVANCE OF DEFECT INSPECTION ARE INVOICED, AND CREDIT IS PENDING INSPECTION OF RETURNED MATERIAL. DEFECTIVE MATERIAL RETURNED BY END USER SHOULD NOT BE REPLACED BY THE DISTRIBUTOR WITHOUT CHARGE TO THE END USER, AS CREDIT TO DISTRIBUTORS ACCOUNT WILL BE PENDING INSPECTION AND VERIFICATION OF ACTUAL DEFECT BY AMERICAN ALDES.

WARRANTY DOES NOT APPLY TO THE FOLLOWING:

- Damages from shipping, either concealed or visible. Claim must be filed with the carrier.
- Damages resulting from improper wiring or installation.

- Damages caused by acts of nature, or resulting from improper consumer procedures such as:

- a) Improper Maintenance,
- b) Misuse, abuse, abnormal use, or accident, or
- c) Incorrect electrical voltage or current.
- d) Removal or alterations made on the AMERICAN ALDES label control number or date of manufacture.

- Any other warranty, expressed, written or implied, and to any consequential or incidental damages, loss of property, revenues, or profit, or costs of removal, installation or reinstallation, for any breach of warranty.

WARRANTY VALIDATION:

The end user must keep a copy of the Bill of Sale to verify purchase date.

These warranties give you specific legal rights, and are subject to an applicable consumer protection legislation. You may have additional rights which vary from state to state.

LIMITATION OF WARRANTY AND LIABILITY

This warranty does not apply to any AMERICAN ALDES product or part which has failed as a result of faulty installation or abuse, incorrect electrical connections or alterations made by others, or use under abnormal operating conditions or misapplication of the product or parts. We will not approve for payment any repair not made by us or our authorized agent without prior written consent. The foregoing shall constitute our sole and exclusive warranty and our sole and exclusive liability, and is in lieu of any other warranties, whether written, oral, implied or statutory. There are no warranties which extend beyond the description on the page hereof. In no event, whether as a result of breach of contract, or warranty or alleged negligence, defect, incorrect advice or other causes, shall AMERICAN ALDES be liable for special or consequential damages, including, but not limited to, loss of profits or revenue, loss of use of equipment or any other associated equipment, cost of capital, cost of substitute equipment, facilities or services, downtime costs, or claims of customers of purchases for such damages. AMERICAN ALDES neither assumes or authorizes any person to assume for it any other liability in connection with the sale of its products or parts. Some jurisdictions do not allow the exclusion or limitation of incidental or consequential damages, so the above limitations and exclusions may not apply to you. American ALDES reserves the right to modify, at any time and without notice, any or all of its products' features, designs, components and specifications to maintain their technological leadership position.



4537 NORTHGATE COURT
SARASOTA, FL 34234-2124, USA
TEL: 941-351-3441
FAX: 941-351-3442
www.americanaldes.com or www.ventzone.com
email: info@aldes-us.com

