

# READ COMPLETE SAFETY INSTRUCTIONS AND INSTALLATION TEMPLATE BEFORE STARTING

**Attention Installer: WARNING** This product must be installed by a qualified heating and air conditioning contractor. Failure to do so, could result in serious injury from electrical shock. This product must be installed in compliance with all local, state and federal codes.

## Aprilaire® AUTOMATIC HUMIDIFIER MODEL 400

The Model 400 Aprilaire can be installed on either the supply or return plenum of a forced air handling system and is easily reversible for installation with right hand or left hand bypass pipe connections. Read complete instructions before mounting the humidifier. The unit is 15" x 14<sup>3</sup>/<sub>8</sub>" x 10". The dimensions and serviceability must be considered when selecting the best location for the unit.

### WARNING

1. Disconnect electrical power to the furnace before starting installation. Failure to do so could result in serious injury from electrical shock.
2. Sharp edges may cause serious injury from cuts. Use care when making plenum openings and handling ductwork.
3. Hot water temperatures in excess of 125°F. may cause serious injury from burns. Make sure water supply is shut off before connecting the water supply.
4. Do not set humidity higher than recommended. Condensation damage may result.
5. Do not connect the transformer of the Model 400 to multi-speed furnace blower motors or blower motors other than 120 VAC. Premature component failure may result. Use Research Products Corporation Model 50 Current Sensing Relay.
6. Do not set humidity up to recommended levels if there is condensation on the inside windows of any unheated living space. Condensation damage may result.
7. When installing Humidifier Control on downflow furnace, ensure blower continues to run after a heat call is satisfied to eliminate high temperatures from damaging the Humidifier Control.
8. Do not install humidifier where water pressure exceeds 125 psi, since damage to the unit may result. Follow codes in effect concerning pressure reduction.

### CAUTION

1. Do not install unit where freezing temperatures could occur.
2. Do not install unit or bypass connection on the furnace jacket.
3. Do not install unit or bypass connection on a plenum face where the blanked off ends of the cooling coil restrict air movement through the humidifier.

NOTE: SIX (6) #8 X 3/4" PLATED HEX HEAD SMS SCREWS (NOT FURNISHED) ARE REQUIRED FOR INSTALLATION.

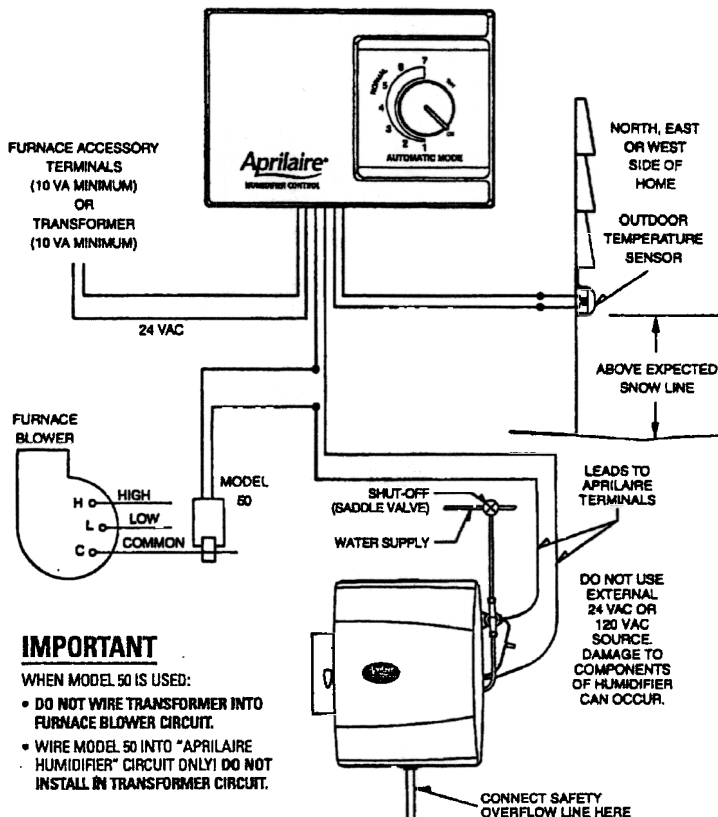

### IMPORTANT

- WHEN MODEL 50 IS USED:
- DO NOT WIRE TRANSFORMER INTO FURNACE BLOWER CIRCUIT.
  - WIRE MODEL 50 INTO "APRILAIRE HUMIDIFIER" CIRCUIT ONLY! DO NOT INSTALL IN TRANSFORMER CIRCUIT.

### NOTE

FOR INSTALLATION IN MANUAL MODE, REPLACE OUTDOOR TEMPERATURE SENSOR WITH PLASTIC RESISTOR CASE AND ATTACH MANUAL FACE PLATE. SEE FORM #DP10005402 FOR COMPLETE WIRING INSTRUCTIONS, INCLUDED WITH EACH HUMIDIFIER.

### NOTE

SOME FURNACES ARE EQUIPPED WITH ACCESSORY TERMINALS THAT CAN BE USED FOR THE HUMIDISTAT. THE RP MODEL 50 CURRENT SENSING RELAY (NOT FURNISHED) MAY NOT BE NECESSARY IN THIS CASE. CONSULT THE FURNACE MANUFACTURER'S RECOMMENDATIONS FOR WIRING.

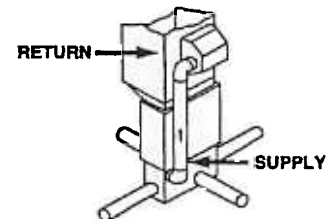

Downflow

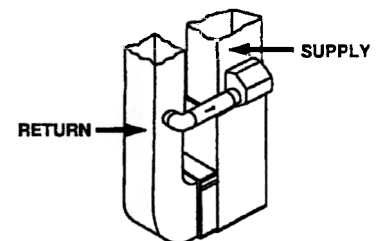

Upflow

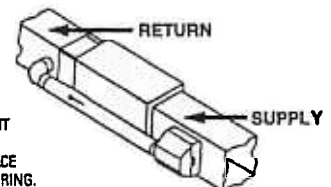

Horizontal

**READ COMPLETE SAFETY INSTRUCTIONS AND INSTALLATION TEMPLATE BEFORE STARTING  
TEMPLATE MUST BE LEVEL**

# Aprilaire® AUTOMATIC HUMIDIFIER MODEL 400

Unpack the contents of the Model 400 box. Look at the drawing and parts list and make sure all the parts are present.

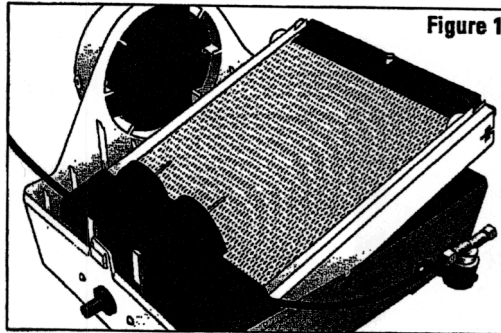

Figure 1

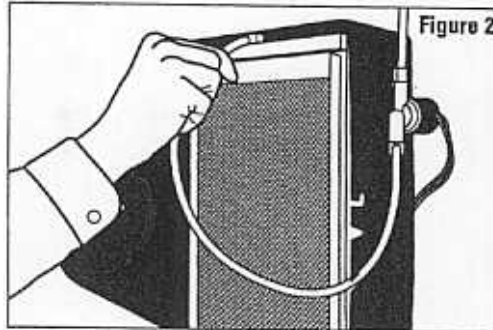

Figure 2

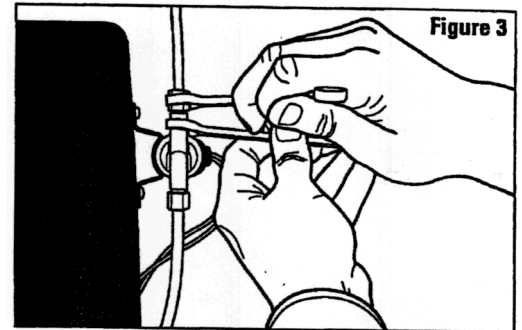

Figure 3

**1.** Remove front cover by pressing center tabs on top and bottom of the cover (1) and base (2). Pull feed tube (3) out of water distribution tray (4). Lift the Water Panel Evaporator assembly out of the base. (See Figure 1)

**2.** The unit comes assembled for left side discharge. If converting to right side discharge, the base can be rotated so round collar is facing to the right. Remove hole plug (10)

by twisting and pushing out. Remove two screws holding water level sensor assembly (9) and lift. On back of sensor assembly (9), move wires from right side retaining clip to left side retaining clip. Reinstall sensor assembly and hole plug on opposite sides of base (2). Press wires back into slot inside base (2).

**3.** Using a level, position this template at least 3" above the furnace

housing or cooling coil, if applicable, for clearance of the safety overflow line. Trace around template edges. Remove it and cut the plenum opening.

Place the unit into the plenum opening, install six #8 x 3/4" Plated Hex Head SMS screws (not furnished) at the top and sides of the unit interior.

**4.** Install a 6" collar in a convenient location on the opposite plenum.

Attach a 90° elbow and measure the length of 6" round duct required to make the connection. Attach duct with sheet metal screws. Support bypass duct in excess of 4' to prevent sagging.

**5.** Re-install the Water Panel Evaporator assembly back into the base, making sure the bottom of the water panel assembly is properly seated on the sensor assembly. Make sure both float stems extend through openings in float cover and that floats move freely up and down. Push the feed tube back into the water distribution tray. (See Figure 2) If the nameplate in the cover (11) is upside down, remove it by gently squeezing the tabs of the nameplate from inside the cover and pushing out. Rotate the nameplate so it is right side up, and snap back into place. Put the front cover back on. Turn damper handle (8), to the open position "winter" for the heating season or closed position "summer" for the cooling season.

**6.** Install the Aprilaire Humidifier Control in the return air duct using the installation instructions enclosed. See reverse side for wiring diagram. For detailed installation and wiring instructions see form #DP 10005402, included with humidifier.

Wire 24 VAC transformer to power source other than furnace fan motor circuit. Transformer can be powered off the 120 VAC line at the junction box before it enters

furnace or from 120 VAC furnace accessory terminals. See furnace manufacturer's recommendations for wiring.

**7.** Tap into a water supply line with the saddle valve furnished. The humidifier will function with cold, hot, softened, or unsoftened water.

**NOTE:** The saddle valve is designed to be fully opened or closed. Do not use it to regulate water flow.

**8.** Connect tubing from the saddle valve to the inlet side of the solenoid valve using 1/4" O.D. copper tubing (not furnished). **DOUBLE WRENCH TO PREVENT LEAKING!** (See Figure 3)

**9.** Connect 1/2" I.D. plastic hose (not furnished) to safety overflow line connection at base of unit and direct to floor drain. Be sure hose has continuous slope.

**NOTE:** Do not sweat or directly attach metal line to fitting. Do not use solvent type adhesive when connecting plastic hose, since damage to fitting could result.

**10.** Open saddle valve completely and turn on furnace. Check to see if unit is water tight and all electrical components function properly by utilizing humidification system check out section of Aprilaire Humidifier Control Installation Instructions, form #DP 10005402.

**NOTE:** Both floats must be at bottom of float chamber for humidifier to operate, even in test mode.

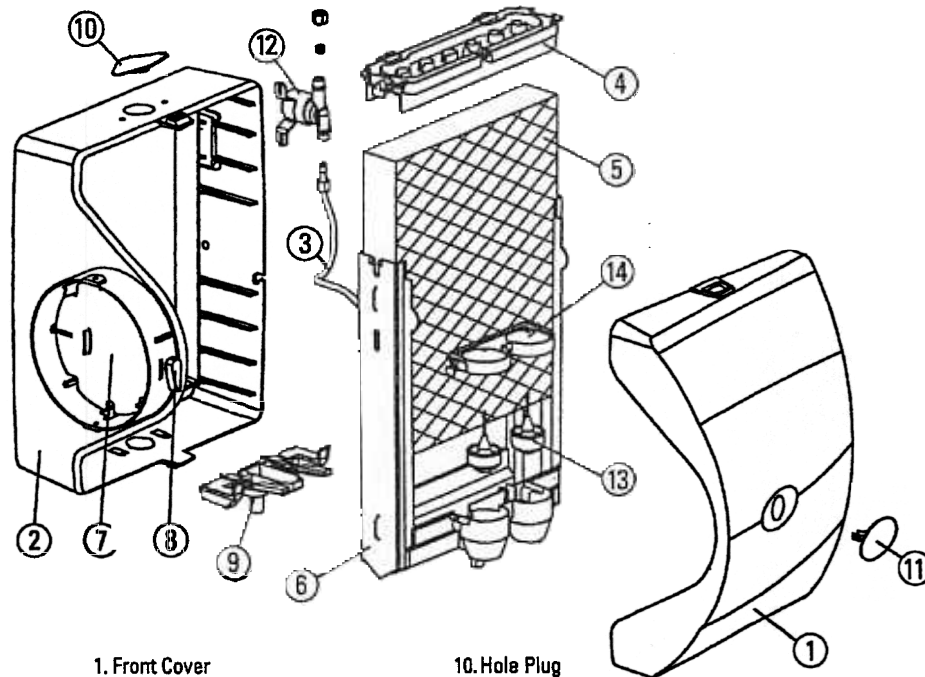

- 1. Front Cover
- 2. Base
- 3. Feed Tube
- 4. Water Distribution Tray
- 5. Water Panel
- 6. Scale Control Insert/Float Chamber
- 7. Integral Damper
- 8. Damper Handle
- 9. Water Level Sensor Assembly

- 10. Hole Plug
- 11. Nameplate
- 12. Solenoid Valve
- 13. Float
- 14. Float Cover

**IMPORTANT!** Be sure warranty card and owner's manual containing instructions explaining operation of unit are given to owner in order to save unnecessary calls. Warranty card should be filled out and sent to factory immediately following installation. Warranty is void unless unit is installed by qualified heating and air conditioning contractor due to possible misapplication of product.