



# TJERNLUND PRODUCTS, INC.

1601 Ninth Street • White Bear Lake, MN 55110-6794  
PHONE (800) 255-4208 • (651) 426-2993 • FAX (651) 426-9547  
Visit our web site • www.tjernlund.com



## AIRESHARE™ ROOM-TO-ROOM VENTILATOR MODEL AS1P

**READ OWNERS INSTRUCTIONS CAREFULLY PRIOR TO INSTALLATION. THESE INSTRUCTIONS MUST REMAIN WITH EQUIPMENT. DO NOT DESTROY.**

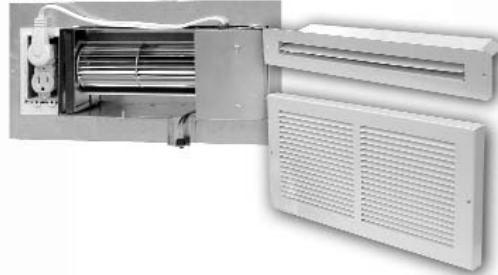

### DESCRIPTION

The Tjernlund AireShare™ Room-to-Room Ventilators distribute air from one space to another. Virtually, every home has a room that is uncomfortably hot or cold from which some of that room's air can be shared with an adjacent room, making the temperature of both rooms more comfortable. The AireShare transfers air through the wall cavity created between two wall studs. The AireShare's unique option of moving the air up or down within the wall cavity allows for optimum heat transfer between rooms – a typical application will change the temperature 3 °F per hour. In addition, locating the grill and diffuser, one high the other low, prevents the transfer of light and sound between these adjacent rooms.

### SPECIFICATIONS & COMPONENTS

#### MODEL AS1P

Blower: 75 cfm  
Motor: 115 Volts ~ 60 Hz  
0.50 amps maximum  
Impeller: Transtangential, cross-flow  
Dimensions:  
Diffuser: 2 1/4" x 14 5/8" (flush)  
Grill: 7 7/8" x 15 7/8"  
Color: Neutral White  
Power Cord: 12" long, grounded  
On/Off Switch: 120 Volts; rated to 100,000 cycles

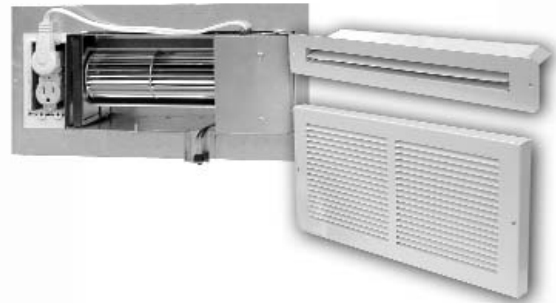

### GENERAL INFORMATION

Every Tjernlund AireShare™ Room-to-Room Ventilator is electrically factory line tested before shipment.

After opening carton, inspect thoroughly for shipping damage. Impeller should rotate freely and all electrical wires and connections should be secured. If any damage is found, notify freight carrier and your distributor immediately and file a concealed damage claim.

### INSTALLATION RESTRICTIONS

The AireShare™ Ventilator must be installed by a qualified installer in accordance with these instructions and all local codes or in their absence in accordance with the latest editions of the International Residential Code and International Electrical Code. Improper installation can create a hazardous condition such as fire, electric shock or personal injury. To reduce these risks, significantly, use this device only in the manner intended by the manufacturer. If you have questions about proper usage of this device, call Tjernlund Products.

Always disconnect the AireShare™ Ventilator from its power source before installation and servicing.

**IMPORTANT:** An in depth investigation of the wall layout is required prior to installation. Avoid a stud wall section that is a path for plumbing supply lines, drains and vents. Avoid a stud wall section that is insulated or being used as a return air duct for a forced air system. If stud walls are constructed with metal studs the Diffuser must be mounted 3" above the Blower opening since metal studs typically are not solid throughout.

## ⚠️ WARNING

- The AireShare™ may not be used to exhaust hazardous or explosive materials or vapors.
- The AireShare™ may not be installed in a ceiling.
- The AireShare™ may not be installed in an outside wall.
- The AireShare™ may not be installed in a wall rated as a “fire wall.”
- The AireShare™ may not be used to move air from one floor (story) to another floor.
- The AireShare™ may not be used to move moisture-laden air from sources such as bathrooms and kitchens.
- The AireShare™ may not be used in a window.

**WARNING:** To reduce the risk of fire, electrical shock and injury to persons, the AireShare™ must be installed with the AS1P Diffuser that was provided with the AS1P. Do not use this product without the AS1P Diffuser or with any Diffuser other than the AS1P Diffuser.

**WARNING:** To reduce the risk of fire or electrical shock, do not use this fan with any solid state speed control devices.

## ⚠️ WARNING

**Disrupt power at circuit breaker to outlets within the stud wall you will be working.**

When sawing through sheetrock you must stop if you detect the saw blade coming in contact with any wiring or plumbing. Investigate further to determine if possible to safely still use this wall cavity space. Switch to another stud wall cavity if necessary.

### BEFORE YOU START:

Determine the stud wall section that you want to use to mount the Blower and Diffuser. You **must** select a stud wall section that contains an electrical outlet, (See Diagram A). **IMPORTANT: Wall studs must be spaced a minimum of 16” o.c., (See Diagram B).** Mark inside edges of studs the AireShare will be installed between and verify there is at least 14” between the inside edges. Slide a stud finder down the wall between the studs to verify the stud wall cavity is completely open, (See Diagram C).

DIAGRAM A

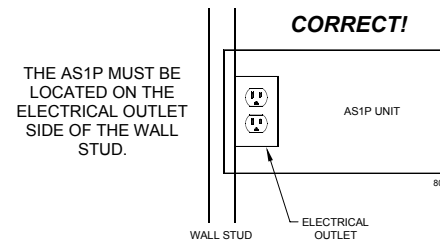
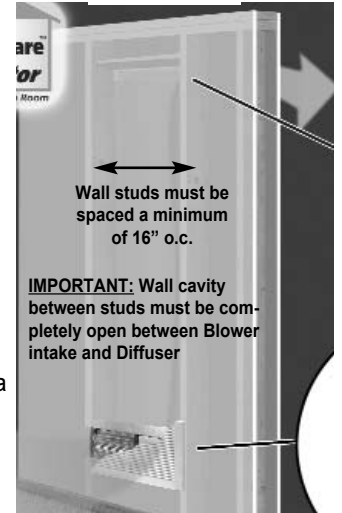

DIAGRAM B



## TOOLS REQUIRED

Sheetrock Saw    Philips & Straight Screwdrivers    Level    Tape Measure    Utility Knife or Scissors

## INSTALLING DISCHARGE DIFFUSER

**IMPORTANT:** Install Diffuser first so sheetrock from the Diffuser cut out does not fall into wall cavity and damage Blower.

**NOTE:** Since electrical outlets are usually not up high, typical installations of the model AS1P will have the Diffuser high and the Blower low.

1. The diffuser may be mounted as close as 3” above the top of Blower cut out opening or as close as 3” to the ceiling.
2. Level and mark a line between studs for top of the Diffuser cut out, (See Diagram D)
3. Using a hand sheetrock saw carefully make a horizontal cut along the line. Cut the sheetrock completely until you come in contact with the opposite stud. **NOTE:** If studs are spaced greater than 16” o.c., the horizontal cut line should not exceed 14”, (See Diagram E).

DIAGRAM C

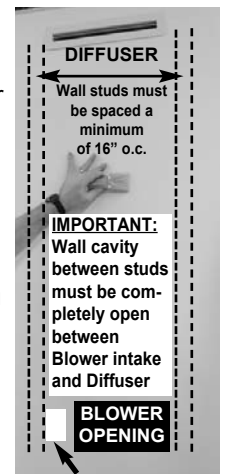

Electrical box must be installed inside stud wall section

DIAGRAM D

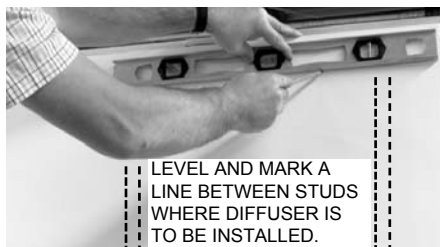
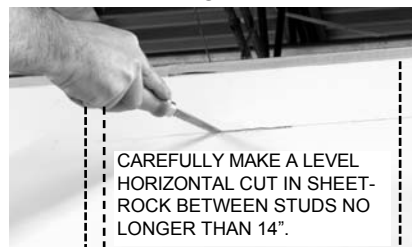

DIAGRAM E



- Cut diffuser template on dashed lines. Align the top of template with the wall cut and center it so that there is an equal space between the right and left edges of the template and ends of the cut in the sheetrock. Mark all 4 corners of template, connect with a straight edge and cut Diffuser opening in wall (**Diffuser opening should be 1 1/4" high x 13 5/8" wide**), (See Diagram F).
- Insert diffuser with the air scoop on the back pointing towards the blower. Adjust tangs on the sides if necessary to secure a tight fit into the wall opening, (See Diagram G).

DIAGRAM F

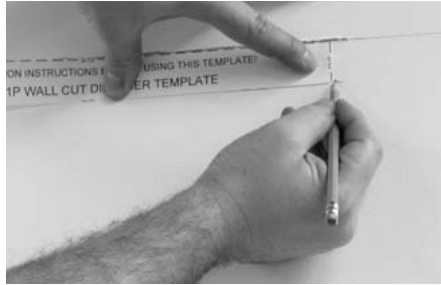
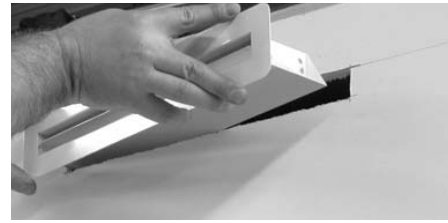

DIAGRAM G



## BLOWER INSTALLATION

**IMPORTANT:** Install Diffuser first when mounting the Blower down low and the Diffuser high so sheetrock from the Diffuser cut out does not fall into wall cavity and damage Blower.

- You **must** select a stud wall section that contains an electrical outlet, (See Diagram H). Mark a vertical line down the side of the outlet box opposite stud. Mark a spot 3/4" above electrical outlet top mounting screw on outlet side opposite stud., (See Diagram H).
- Use a level to draw a horizontal line across to opposite stud, (See Diagram I).
- Using a hand sheet rock saw carefully make a horizontal cut along the line going away from outlet. Cut the sheetrock completely until you come in contact with the opposite stud. **NOTE:** If studs are spaced greater than 16" o.c., the horizontal cut line should not exceed 12 1/2", (See Diagram J).

DIAGRAM H

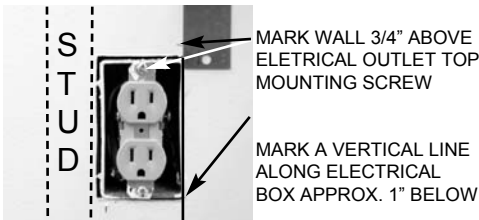

DIAGRAM I

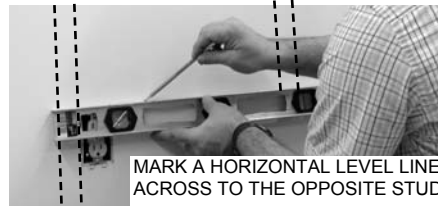
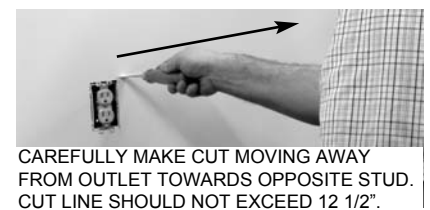

DIAGRAM J



- Align the top corner of AS1P Blower template with horizontal wall cut and vertical line. Mark all 4 corners of template, connect with a straight edge and cut rectangular opening in wall (**Model AS1P Blower opening should be 4 7/8" high x 12" wide**), (See Diagram K).
- With the Blower outlet pointing up rotate the mounting flange so that the electrical outlet cutout is positioned on the side of the Blower housing nearest the electrical outlet. With the bent tabs facing the front of the blower slide the mounting flange from the rear of the blower to the front until the four tabs line up with the holes in the blower housing. Secure with included 8/32 self tapping screws. **NOTE:** If electrical outlet is on the right side of Blower, loosen (2) power switch bracket screws and slide power switch bracket completely over to the right to allow for switch opening on grill. Tighten (2) switch bracket screws, (See Diagram L).
- Carefully insert the blower into the cutout. Level the top flange and mark the larger Blower flange mounting holes. Using the provided wood screws, secure the blower to the wall studs. Use provided wall anchors if not installing into studs, (See Diagram M).

DIAGRAM K

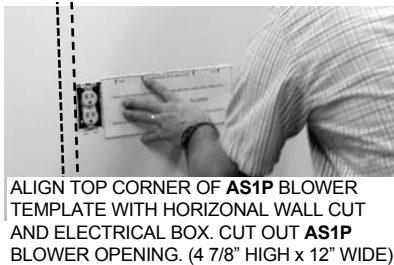

DIAGRAM L

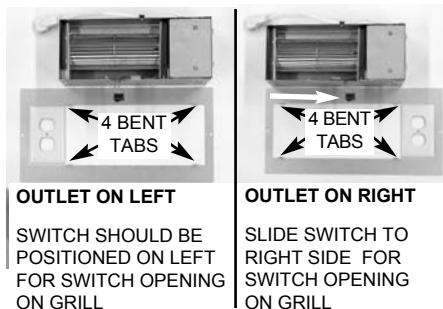

DIAGRAM M



7. Replace the electrical outlet cover. Route the power cord as depicted and plug into outlet, (See Diagram N).

8. Install intake Grill to Blower with provided screws. Notch on bottom must align with on/off switch, (See Diagram O).

DIAGRAM N

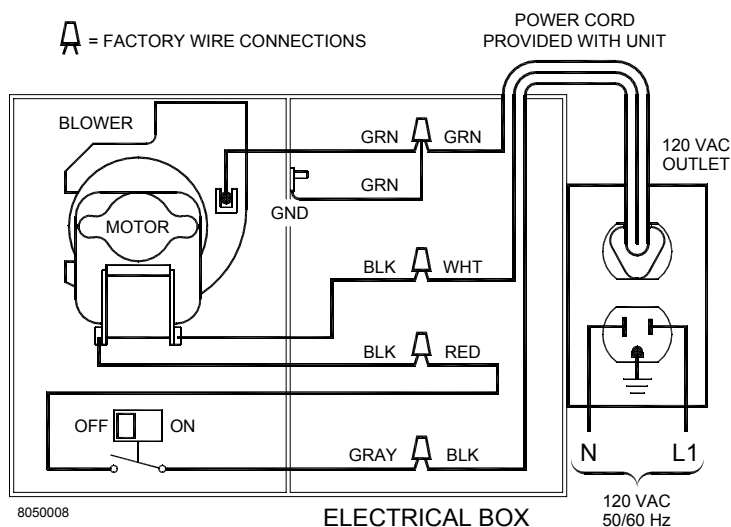

DIAGRAM O



**FACTORY WIRING**

**AIRESHARE MODEL AS1P FACTORY WIRING**



**MAINTENANCE**

The AireShare Blower wheel should be inspected annually and carefully cleaned or vacuumed with a bristle brush head if necessary. The motor is permanently lubricated and requires no maintenance.

**REPLACEMENT PARTS AND WARRANTY**

<u>Component</u>	<u>Part Number</u>	<u>Component</u>	<u>Part Number</u>
AS1P Intake Grill	950-3301	AS1/AS1P Blower Assembly	950-3303
AS1/AS1P Diffuser	950-3302	AS1P On/Off Switch	950-3304

**WARRANTY**

**TJERNLUND LIMITED ONE YEAR WARRANTY**

Tjernlund Products, Inc. warrants to the original purchaser of this product that the product will be free from defects due to faulty material or workmanship for a period of (1) year from the date of original purchase or delivery to the original purchaser, whichever is earlier. Remedies under this warranty are limited to repairing or replacing, at our option, any product which shall, within the above stated warranty period, be returned to Tjernlund Products, Inc. at the address listed below, postage prepaid. THERE ARE NO WARRANTIES WHICH EXTEND BEYOND THE DESCRIPTION ON THE FACE HEREOF, AND TJERNLUND PRODUCTS, INC. EXPRESSLY DISCLAIMS LIABILITY FOR INCIDENTAL OR CONSEQUENTIAL DAMAGES ARISING FROM THE USE OF THIS PRODUCT. THIS WARRANTY IS IN LIEU OF ALL OTHER EXPRESS WARRANTIES AND NO AGENT IS AUTHORIZED TO ASSUME FOR US ANY LIABILITY ADDITIONAL TO THOSE SET FORTH IN THIS LIMITED WARRANTY. IMPLIED WARRANTIES ARE LIMITED TO THE STATED DURATION OF THIS LIMITED WARRANTY. Some states do not allow limitation on how long an implied warranty lasts, so that limitation may not apply to you. In addition, some states do not allow the exclusion or limitation of incidental or consequential damages, so that above limitation or exclusion may not apply to you. This warranty gives you specific legal rights and you may also have other rights which may vary from State to State. Send all inquiries regarding warranty work to Tjernlund Products, Inc. 1601 9th Street, White Bear Lake, MN 55110-6794. Phone (651) 426-2993 • (800) 255-4208 • Fax (651) 426-9547 • Email fanmail@tjfans.com.