



CLIMATE TECHNOLOGY CORPORATION

A Hunter Fan Company  
2500 Frisco Ave.  
Memphis, TN 38114  
800-676-7861

[www.climateproducts.com](http://www.climateproducts.com)



CLIMATE TECHNOLOGY CORPORATION

Touchscreen Programmable Thermostat  
Model 43855  
3 Stage Heat/2 Stage Cool

**installation and  
operation manual**

---

## TABLE OF CONTENTS

IMPORTANT INFORMATION.....	4
INSTALLATION PROCEDURES.....	4
GENERAL OPERATING INSTRUCTIONS .....	21
DATE & TIME SETTINGS .....	22
SYSTEM SETTINGS MENU .....	27
USER SETTINGS MENU .....	31
TEMPERATURE RANGE .....	34
ENERGY STAR DEFAULT PROGRAMS .....	35
MANUAL OPERATION .....	36
PROGRAM OPERATION.....	39
PROGRAM OVERRIDES.....	46
ADDITIONAL FEATURES .....	56
CLEAN SCREEN.....	56
CHANGE FILTER.....	60
ENERGY MONITOR FUNCTION.....	64
TROUBLESHOOTING .....	68
WIRING DIAGRAMS .....	72

---

Touchscreen Programmable Thermostat  
Model 43855  
3 Stage Heat/2 Stage Cool

**Congratulations!**

Thank you for choosing a Climate Technology Corporation programmable thermostat. Your new CTC thermostat will provide years of reliable service and year-round energy savings.

Please read this manual before beginning installation and save this booklet for complete operating instructions.

---

## **IMPORTANT INFORMATION**

This thermostat is designed to work on the following heating and cooling systems:

Up to 3 Stage Heat/2 Stage Cool  
Heat Only or Cool Only Systems  
Single and Multi-Stage Heat Pumps  
Gas, Electric or Oil Systems

Millivolt Systems  
2-wire Hydronic Systems  
AC or Hard-wired

This thermostat is not designed for use with 110V/220 V systems. If you are unsure of what kind of heating and cooling system you have, please contact a qualified HVAC Technician for assistance.

## **INSTALLATION PROCEDURES**

### ***TOOLS***

This thermostat includes two #8 slotted screws and two wall anchors for mounting. To install your new thermostat, you will need the following supplies:

Flat-head screwdriver, Small Phillips-head screwdriver, Hammer  
Electric drill and 3/16" bit, Three 1.5 Volt (AA) size alkaline batteries

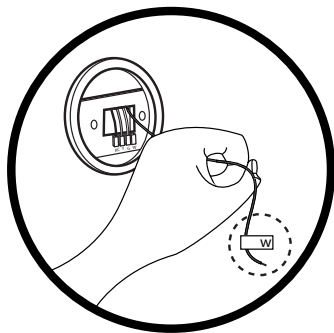

**NOTICE OF CAUTION! DO NOT disconnect the wires from the existing thermostat before reading these instructions. The wires must be labeled prior to removal to ensure proper connection.**

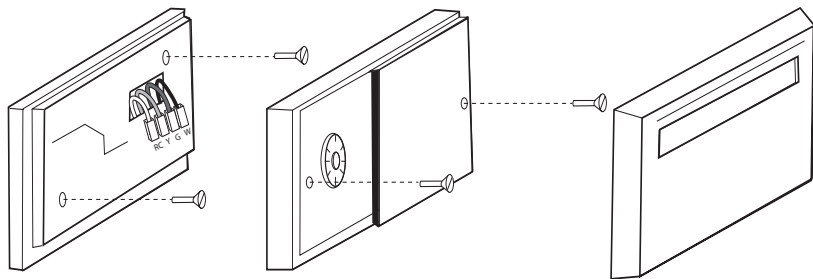
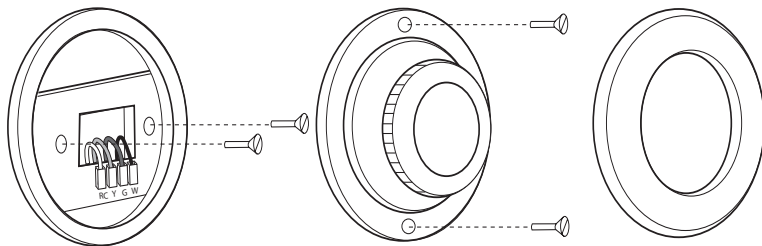

---

## **UNINSTALLING THE EXISTING UNIT**

1. Turn the system power OFF at the existing thermostat. Turn the power to the HVAC system OFF at the main power panel or at the furnace.

(Failure to turn off the power to the existing thermostat before removal could damage your system.)

2. Remove the existing thermostat cover to access the wires from the wall. (Some thermostats may have multiple covers, screws or other locking devices that must be removed or disengaged.)

3. Locate, but do not disconnect the wires.

(If wires are not visible, they may be connected to the back of the wall plate. Some models may have doors that open to expose the wires and mounting screws.)

4. Do not let the wires slip back into the wall during disconnection. You may want to secure the wires to the wall as you disconnect them. After all wires are labeled, disconnect each wire and remove the existing wall plate. (Any unused wires should be capped with an approved electrical connector, such as electrical tape.)





---

## 5. Using the provided stickers, label each wire according to the chart.

If the terminals are not labeled, contact a qualified HVAC technician.

NOTE: Wire colors do not always comply with standards; therefore, wire color should be ignored. Refer to the existing terminal designation for proper identification.

If wires marked "Y" or "C" are both present, "C" may be a Common wire and provides 24 VAC power to the unit. Connecting it greatly extends battery life. If there is no "C" wire, the thermostat will run on battery power.

## CONVENTIONAL HVAC SYSTEMS

if your existing thermostat is marked:

label the wire with this sticker:

if your existing thermostat is marked:

label the wire with this sticker:



Y1	Y2
----	----



R/RC
------



W1	W2	W3
----	----	----



C
---



G
---



H
---



RH
----

See pages 72-73 for a complete wiring diagram.

## HEAT PUMP SYSTEMS

if your existing thermostat is marked:



label the wire with this sticker:



if your existing thermostat is marked:



See pages 74 for a complete wiring diagram.

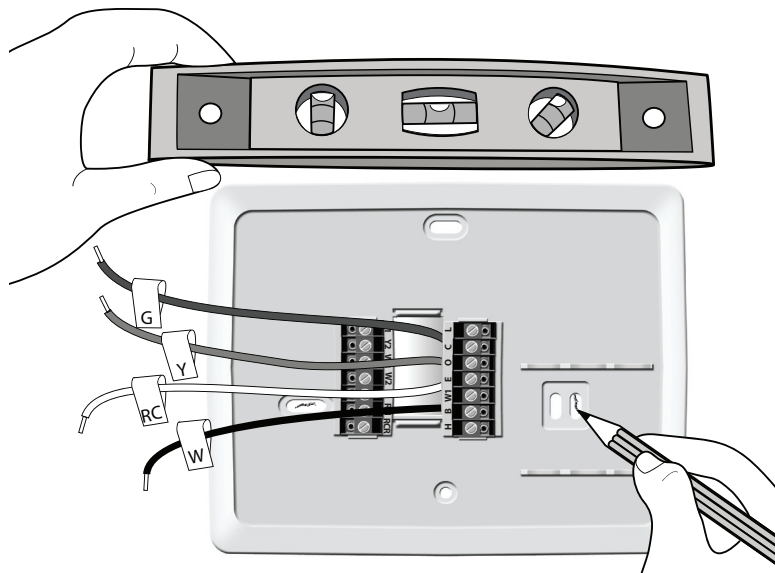

---

## ***MOUNTING THE WALL PLATE***

1. Remove the wall plate from the CTC thermostat by gently pulling the wall plate from the back of the thermostat.
2. Position the new wall plate on the wall horizontally and pull the labeled wires through the opening.
3. If the existing holes do not match those on the CTC thermostat wall plate or, if there are no existing holes, visually level the wall plate and mark the wall for two holes.

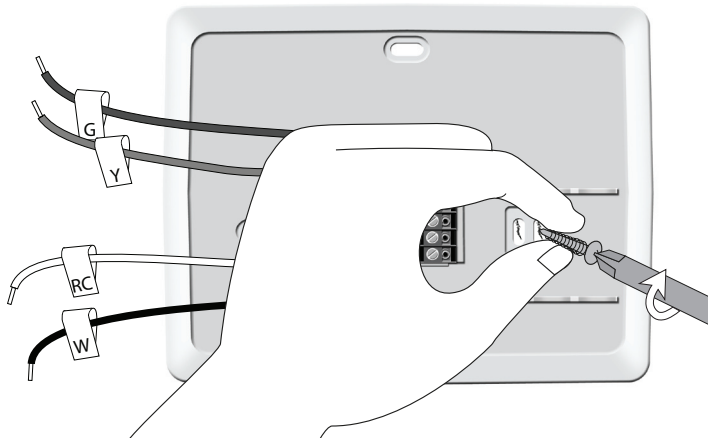

- 
4. Remove the wall plate from the wall and drill two 3/16" holes where marked.
  5. Tap the plastic anchors into the holes until they are flush with the wall.
  6. Reposition the wall plate on the wall, pulling the wires through the wall plate opening. Insert the mounting screws through the wall plate and into the anchors. Verify that the wall plate is level. Securely tighten both screws.



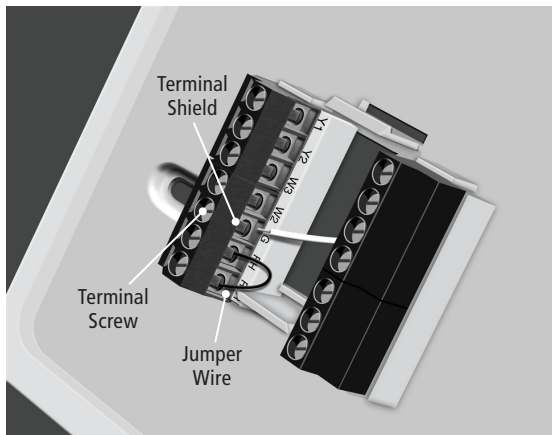

---

## **CONNECTING THE WIRES**

1. Loosen, but do not remove the terminal screws.

NOTE: A jumper wire is provided, connecting the RH and RC terminals for systems that do not have both an RH and RC wire. If you have both an RH and RC wire, remove this jumper; otherwise, leave the jumper in place.

2. Complete wiring diagrams for Conventional HVAC Systems and Heat Pump Systems are provided on pages 72-74. Match and connect the wires from the wall to the terminals as shown. Insert wires behind the black terminal shield. Tighten each screw after the connection is made.
3. Wrap the ends of any extra wires individually in electrical tape and carefully push them into the wall. Push any excess wire length back into the wall to prevent interference.

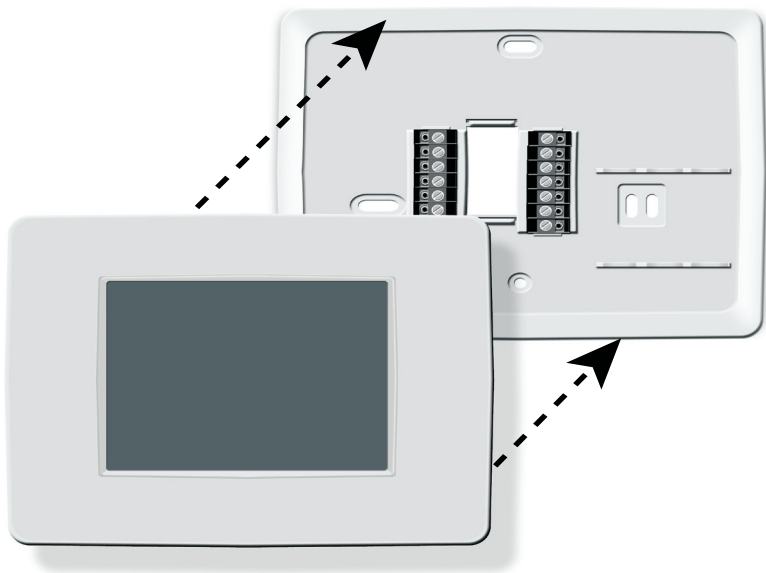

---

## *ATTACHING THE THERMOSTAT*

1. Insert three AA alkaline batteries into the back of the thermostat.
2. Place the thermostat over the wall plate, aligning it over the terminal and battery openings. Press the thermostat to the wall plate and it will snap into place.

NOTE: Do not force the thermostat onto the wall plate as this may damage the terminal pins. If the thermostat does not snap into place easily, the unit may not work.

3. Restore power at the electrical panel and/or furnace.

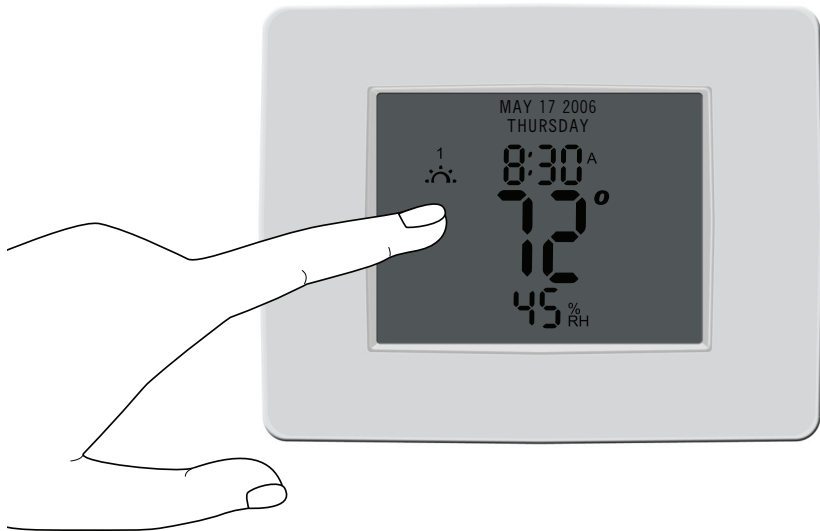

---

## **GENERAL OPERATING INSTRUCTIONS**

Your new CTC thermostat is easy to program and use. The front of the thermostat is a touch screen that responds to the pressure of a finger.

You can program the thermostat to automatically readjust the temperature, humidity and airflow to settings that you choose or you can use the pre-programmed default settings. You can also operate the thermostat manually.

## DATE & TIME SETTINGS

DATE, MONTH, YEAR

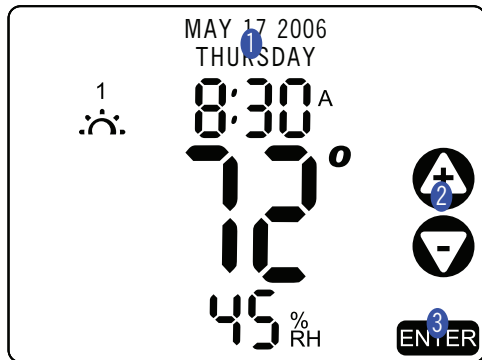

- 
1. Touch either the month, date, year at the top of the touch screen.
  2. Touch the ▲ or ▼ sign to adjust the setting.
  3. Repeat Steps 1-2 for each setting. Touch **ENTER** to return to the main screen.



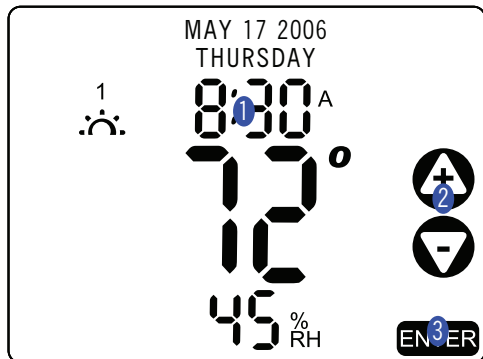

---

## CLOCK



---

The clock is a 12-hour clock with AM and PM settings.

1. Touch the time on the touch screen. SET CLOCK appears and the hour flashes. Note the AM & PM indicators.
2. Touch the  or  sign to adjust the setting.
3. Repeat Steps 1-2 to adjust the minutes setting. Touch **ENTER** to return to the main screen.

NOTE: The clock can be set to automatically adjust for Daylight Savings Time in the USER SETTINGS MENU, see pages 31-33.

---

## SETTING THE SPAN

The SPAN setting mode in the SYSTEM SETTINGS MENU allows you to adjust the system ON/OFF cycle rate. The default setting is 2F. The system cycles ON or OFF when the temperature is within 2°F (1°C) above and below the set temperature. The span setting can be adjusted if your system is cycling too fast or too slowly.

Setting a higher SPAN number increases your cycle time by allowing the system to run longer; a lower number will decrease your cycle time by causing the system to run for a shorter length of time. With the STAGE TIMER (Option 10) set to 0, stages 2 and 3 will be controlled by the SPAN setting only. If the stage timer is set to 30, the system will turn on the next stage based on the SPAN setting or 30 minutes, whichever comes first.

Span settings remain the same for Heating and Cooling.

## SYSTEM SETTINGS MENU

The installer can set SYSTEM functions once the thermostat is installed. The default settings are shown in bold in the following list. Options are listed inside the parentheses. Example: the default SYSTEM TYPE is **CONVENTIONAL** with (HEAT PUMP) as a second option. See pages 28-29 to change these settings.

1. SYSTEM: **CONVENTIONAL**  
(CONVENTIONAL, HEAT PUMP)
2. FURNACE TYPE: **GAS/OIL**  
(GAS/OIL, ELECTRIC)
3. HUMIDITY CONTROL: **ON**  
(ON, OFF)
4. HUMIDITY SPAN (not available if HUMIDITY CONTROL set to OFF): **1**  
(1, 2, 3)
5. STAGE ONE SPAN (defined on page 26): **2F**  
(1F, 2F, 3F)
6. STAGE TWO SPAN (not available on 1H/1C models): **2F**  
(2F, 3F, 4F, 5F, 6F)
7. STAGE THREE SPAN (not available on 1H/1C and 2H/2C models): **3F**  
(2F, 3F, 4F, 5F, 6F)
8. AUTO SEASON SPAN: **5F**  
(3F, 4F, 5F, 6F)
9. TEMPERATURE CALIBRATION: **0F**  
(-2, -1, 0, +1, +2)
10. STAGE TIMER: **0 minutes**  
(0, 30)
11. RESIDUAL COOLING TIMER: **30 seconds**  
(0, 30, 60, 90)
12. RESTORE FACTORY SETTINGS: **NO**  
(YES, NO)

## SYSTEM SETTINGS MENU (CONT'D)

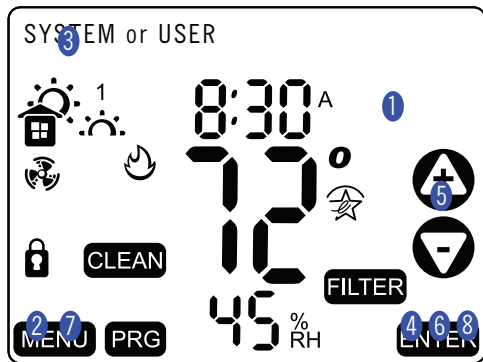

- 
1. Touch a blank area of the touch screen.
  2. Press and hold **MENU** for 3 seconds for SYSTEM and USER settings to appear.
  3. Touch SYSTEM. The selected word flashes.
  4. Touch **ENTER**.
  5. Scroll through the first setting with the ▲ or ▼ sign to select an option. Refer to the list on page 27 for setting options.
  6. Touch **ENTER** to confirm selection and move to next setting.
  7. When all settings are complete, touch **MENU** to exit.
  8. Touch **ENTER** to return to the main screen.

---

## *USER SETTINGS*

The PERIODS PER DAY (Option 1) can be set to 0, 2 or 4. When set to 0, the thermostat operates as a digital non-programmable thermostat.

The FILTER CHANGE INDICATOR (Option 2) runs in calendar days and can be set from 30-360 days in 15-day increments (the default is 90).

The REFRESH FAN ON (Option 3) function runs only the fan during heating or cooling off cycles. This balances the indoor air and improves air quality by cycling the air through the filter.

## USER SETTINGS MENU



The USER can also set certain functions in the USER SETTINGS MENU. The default settings are shown in bold in the following list. Options are listed inside the parentheses. Example: the default PROGRAMS PER DAY is **4 Periods** with (0 and 2) as options. See pages 32-33 to change these settings.

1. PROGRAMS PER DAY: **4 Periods**  
(0, 2, 4)
2. FILTER CHANGE DAYS: **90 Days**  
(30-360, in 15 day increments)
3. REFRESH FAN ON TIME: **15 Minutes**  
(10, 15, 20, 30)
4. CLOCK DISPLAY: **ON**  
(ON, OFF)
5. HUMIDITY DISPLAY: **ON**  
(ON, OFF)
6. DAYLIGHT SAVING: **ON**  
(ON, OFF)
7. TOUCHPAD BUZZER: **ON**  
(ON, OFF)
8. TEMP SCALE: **F**  
(Fahrenheit, Celsius)
9. LCD CONTRAST: **5**  
(0-9)

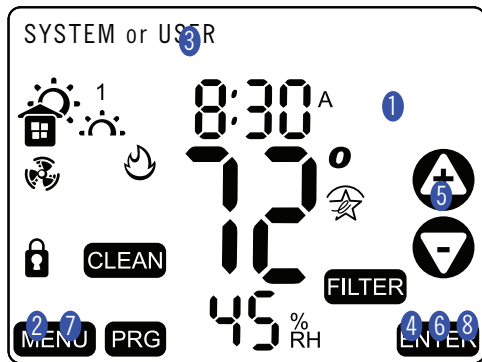

## USER SETTINGS MENU (CONT'D)



- 
1. Touch a blank area of the touch screen.
  2. Press and hold **MENU** for 3 seconds for SYSTEM and USER settings to appear.
  3. Touch USER. The selected word flashes.
  4. Touch **ENTER**.
  5. Scroll through the first setting with the  or  sign to select an option. Refer to the list on page 31 for setting options.
  6. Touch **ENTER** to confirm selection and move to next setting.
  7. When all settings are complete, touch **MENU** to exit.
  8. Touch **ENTER** to return to the main screen.

## TEMPERATURE RANGE

This thermostat meets ENERGY STAR guidelines for energy efficiency. By using the preprogrammed and default settings, this thermostat can save you money by optimizing energy usage in heating and cooling.

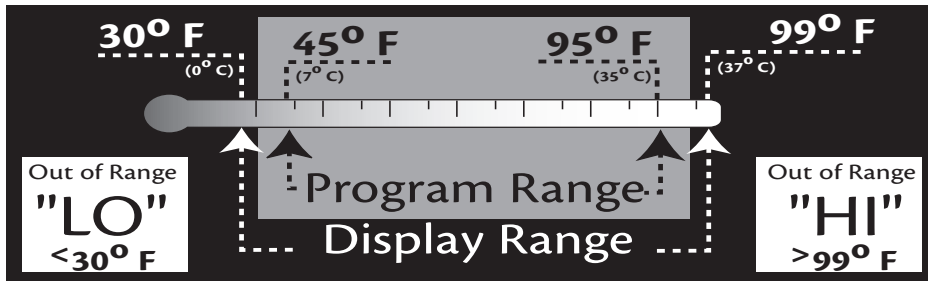

## ENERGY STAR DEFAULT PROGRAMS

Refer to the Energy Star Default Programs Chart shown below for detailed Information about pre-programmed settings. If customizing your programs, you can revert to the Energy Star default programs below by pressing the  icon in the program mode.

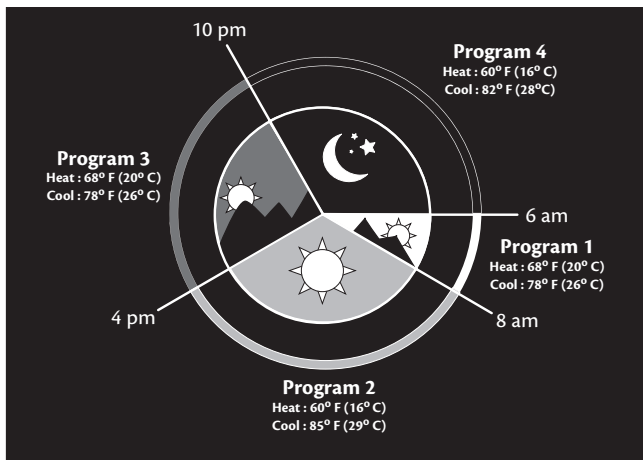





## MANUAL OPERATION

Many people prefer to operate their thermostats manually, adjusting settings as needed.

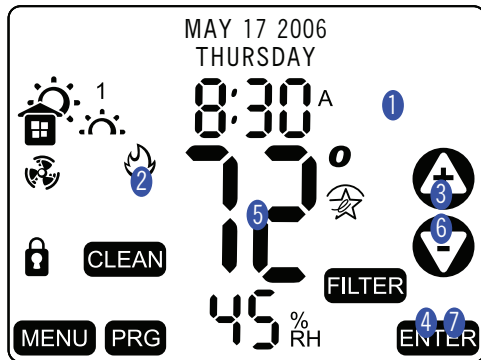
NOTE: PROGRAMS PER DAY must be set to 0 for manual operation. See USER SETTINGS MENU (pages 31-33).

### SET HEAT OR AC SYSTEM MODE



- 
1. Touch a blank area of the touch screen. SELECT FUNCTION appears.
  2. Touch the  or  icon. SET SYSTEM MODE appears.
  3. Scroll through the settings with the  or  sign to select one of the SYSTEM modes:

**HEAT** ( icon, red screen)



**EMHEAT** (only for Heat Pump Systems)

**AUTO** ( and  icons)



**COOL** ( icon, blue screen)

**OFF** (no icon)

4. Touch **ENTER** to return to the main screen.

The  icon will show on the main screen if the system is heating; the  icon will show if the system is cooling.

NOTE: If the system is running and the  or  icon is touched on the main screen, it will return you to the SET SYSTEM MODE screen. Repeat steps 2-4 to make changes.

5. Touch the temperature icon ().
6. Touch the  or  sign to adjust the temperature.
7. Touch **ENTER** to return to the main screen.



## PROGRAM OPERATION

### CREATING CUSTOM PROGRAMS

You can program the thermostat to automatically adjust the temperature, humidity and airflow up to four times per day. The PROGRAMS PER DAY setting must be set to 2 or 4 in USER SETTINGS, see pages 31-33.

NOTE: Program times are set in 10-minute increments. When setting a program time, note the AM and PM indicators. Program temperatures are set in increments of 1°F (1°C). After 15 seconds of inactivity during programming, the thermostat returns to the main display. Press **ENTER** to exit Program Mode at any time. To review any existing programs, touch any period icon to see selections.

### PERIOD ICONS

The program periods are indicated by the following icons:









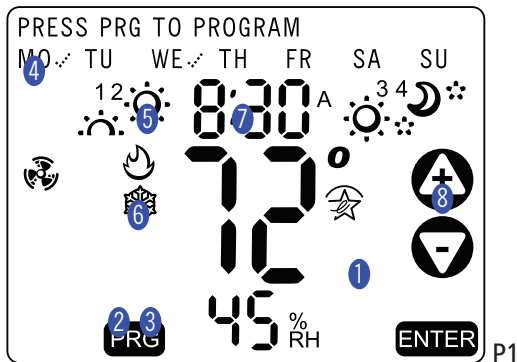



## CREATING CUSTOM PROGRAMS (CONT'D)

This thermostat has an autorecovery function and will automatically calculate the time needed to achieve the temperature you set. Therefore, it will be at the temperature you select at the time you select. (Step 7, page 41).



- 
1. Touch a blank area of the screen to begin programming. SELECT FUNCTION appears at the top of the display. (Image P1)
  2. Touch the  icon. PRESS PRG TO PROGRAM appears at the top of the display along with the days of the week.

NOTE: Either 2 or 4 PERIOD icons will display depending upon how many were selected in USER SETTINGS.

3. Touch the  icon again. SELECT ICON TO PROGRAM appears at the top of the display. (Image P2)
4. Touch the day(s) to be programmed. A check mark is placed next to each day selected.
5. Touch one of PERIOD icons for program settings. The selected PERIOD icon flashes until another period is selected or  or  is touched.
6. Touch the  or  icon to select mode.
7. Touch the time display to set the program start time.
8. Touch the  or  sign to adjust hours and minutes.

## CREATING CUSTOM PROGRAMS (CONT'D)

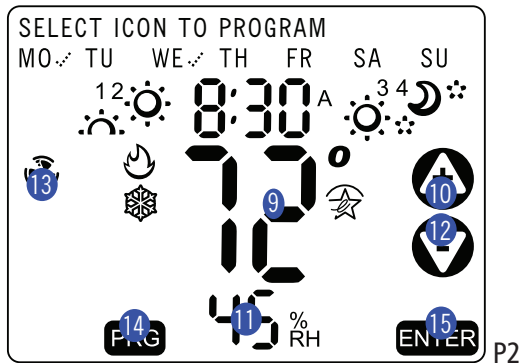

---

9. Touch the temperature display to set the temperature.

10. Touch the  or  sign to adjust numerals.

11. Touch the humidity display to set the humidity.

12. Touch the  or  sign to adjust numerals.

NOTE: Touch  to set the selected period to Energy Star settings. See page 35.



13. Touch  repeatedly to select fan mode (ON, AUTO, or REFRESH).

14. Touch **PRG** to save the settings for the selected days/period and to select new days/period for programming.

15. Repeat instructions 1-14 to select new days and time periods to be programmed or press **ENTER** to save programs and return to the main display.

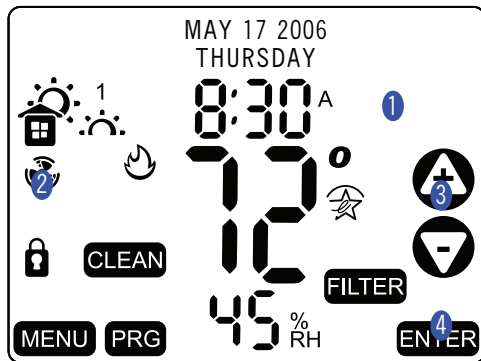
## FAN PROGRAM MODE



- 
1. Touch a blank area of the touch screen. SELECT FUNCTION appears.
  2. Touch the  icon. SET FAN TO PROGRAM MODE appears.
  3. Scroll through the fan settings with the  or  sign to select one of the fan modes:

ON: Fan runs continuously regardless of the system mode.

AUTO: Fan runs when the system is on.

REFRESH: Fan runs on a set interval if the system does not cycle on for one hour.

PROGRAM: Fan is controlled by the settings in the programs.

4. Touch **ENTER** to return to the main screen.

The  icon will show on the main screen if the fan is running.

NOTE: If the fan is running and the  icon is touched, it will bring up the SET FAN screen.

## PROGRAM OVERRIDES

You can either temporarily override the settings for the current program, or permanently override all settings and adjust temperatures manually.

### TEMPORARY OVERRIDE SETTINGS

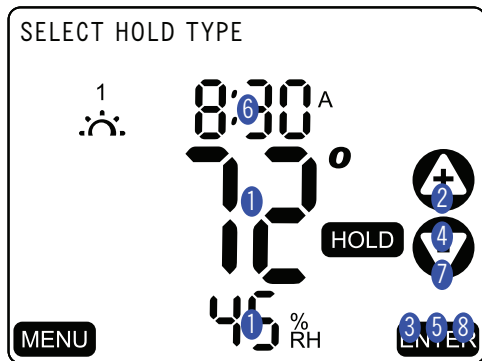

- 
1. Touch the temperature icon (12°) or humidity icon (45%RH). The selected icon will flash and SET OVERRIDE TEMPERATURE or SET OVERRIDE HUMIDITY appears, depending upon your selection.
  2. Touch the ▲ or ▼ sign to adjust the setting.
  3. Press **ENTER** and the screen displays SELECT HOLD TYPE.
  4. Touch the ▲ or ▼ sign to select TEMPORARY HOLD.
  5. Press **ENTER** and the screen displays TEMPORARY HOLD – HOLD UNTIL.
  6. Touch the hour and minutes and use the ▲ or ▼ sign to set the ending time.
  7. To put both temperature and humidity on the same hold press the other icon and repeat steps 1-2.
  8. Press **ENTER** and the main display shows HOLD.





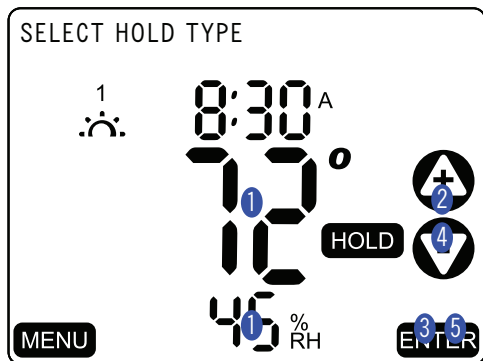

## PERMANENT OVERRIDE SETTINGS

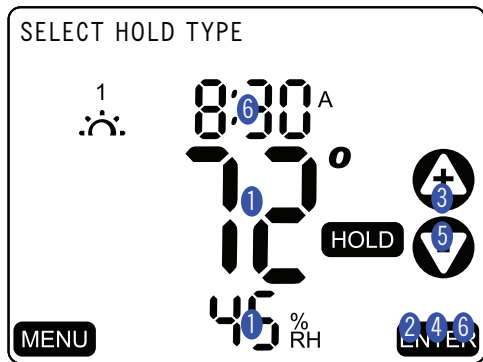

- 
1. Touch the temperature icon (72°) or humidity icon (45%RH). The selected icon will flash and SET OVERRIDE TEMPERATURE or SET OVERRIDE HUMIDITY appears, depending upon your selection.
  2. Touch the ▲ or ▼ sign to adjust the setting.
  3. Press **ENTER** and the screen displays SELECT HOLD TYPE.
  4. Touch the ▲ or ▼ sign to select PERMANENT HOLD.
  5. Press **ENTER** and the main display shows HOLD.

## VACATION OVERRIDE SETTINGS



- 
1. Touch the temperature icon (72°) or humidity icon (45%RH). The selected icon will flash and SET OVERRIDE TEMPERATURE or SET OVERRIDE HUMIDITY appears, depending upon your selection.
  2. Press **ENTER** and screen displays SELECT HOLD TYPE.
  3. Touch the  or  sign to select VACATION HOLD.
  4. Press **ENTER** and the main display shows VACATION HOLD.  
SET NUMBER OF DAYS. Numeral flashes.
  5. Touch the  or  sign to adjust the number of days.
  6. Press **ENTER** and the main display shows HOLD.

---

## CANCEL TEMPERATURE OR HUMIDITY HOLD

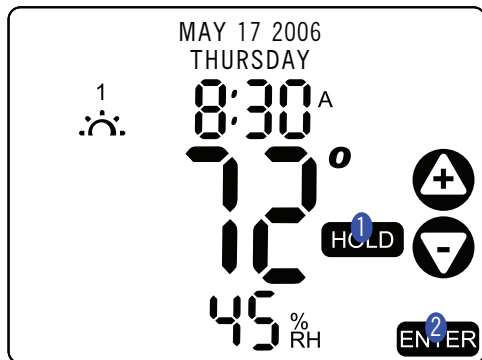

- 
1. Touch the **HOLD** icon. CANCEL TEMPERATURE HOLD appears.
  2. Press **ENTER**, the hold is released and main display returns.

NOTE: If the Temperature or Humidity is touched and override screens appear but no changes are made, the HOLD remains and the main display returns.

## HOME TODAY FUNCTION

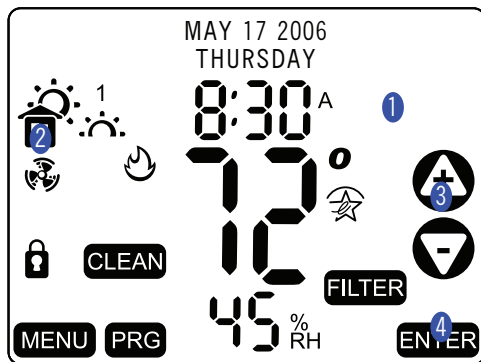

HOME TODAY overrides the program settings for periods 1, 2, and 3 with comfortable heat or cool settings while you are home. HOME TODAY ends when period 4 begins.



---

1. Touch a blank area of the touch screen.

2. Touch the  icon.

3. Touch the  or  sign to toggle between SET HOME TODAY and CANCEL HOME TODAY.

4. Touch **ENTER** to return to the main display.

The  icon will show on the main screen if it is activated.

5. Touch the  icon and press **ENTER** to deactivate the HOME TODAY feature.



## ADDITIONAL FEATURES

The CLEAN SCREEN FUNCTION allows 30 seconds to clean the touch screen without disturbing the existing settings.

### CLEAN SCREEN

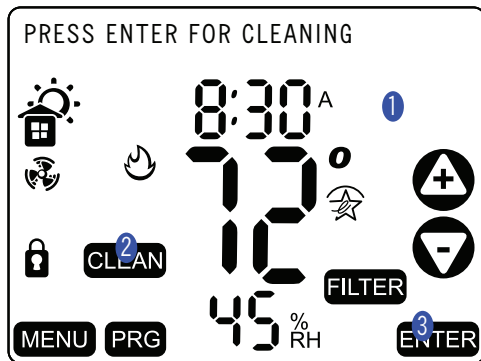



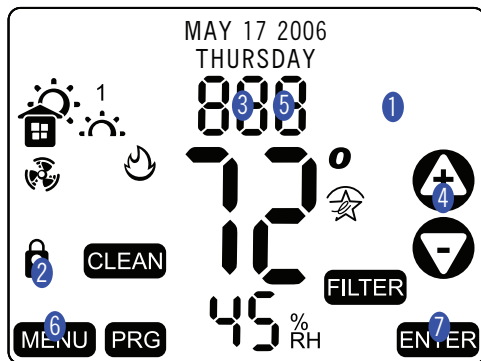

- 
1. Touch a blank area of the touch screen.
  2. Touch **CLEAN**. **PRESS ENTER FOR CLEANING** appears.
  3. Press **ENTER** to return to the main screen. A 30-second countdown begins to allow time to clean the touch screen.
  4. Use a damp cloth with a non-corrosive solvent such as water or a household glass cleaner to clean the screen.

## LOCK FUNCTION

The lock function allows a user to lock the touch screen to prevent unexpected or accidental changes.



- 
1. Touch a blank area of the touch screen.
  2. Touch the  icon. **888** appears.
  3. Touch **888** once for the first digit, twice for the second and three times for the third digit.
  4. Touch the  or  sign to adjust the setting.
  5. Repeat 3-4 for each digit.
  6. Touch **MENU** to return to the menu screen.
  7. Touch **ENTER** to confirm code and return to main screen.

The  icon will appear on the main screen.

NOTE: Once a code is set, touching the  function on the main screen will bring the user to ENTER CODE TO UNLOCK. Enter your code or use 777 which is the master unlock code.

## CHANGE FILTER

The FILTER CHANGE indicator icon will flash after the filter life counter expires as a reminder to check or change your HVAC filter. Reset the filter function after you have changed the filter. The filter change counter is set in the USER SETTING MENU for a period of 30-360 days.

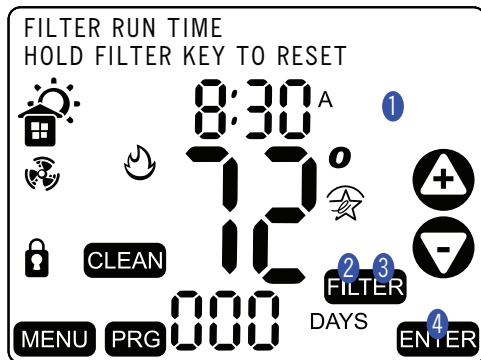

- 
1. Touch a blank area of the touch screen.
  2. Touch **FILTER**. FILTER RUN TIME and HOLD FILTER KEY TO RESET appear on the display.
  3. Touch and hold **FILTER** for 3 seconds for time to reset. (Pressing the filter button for less than 3 seconds will cause the Filter indicator icon to continue to appear.)
  4. Press **ENTER** to return to the main screen.

---

## ***CHANGE BATTERIES***

The CHANGE BATTERIES warning indicates two stages of battery power shortage. When the batteries are weak, the CHANGE BATTERIES warning flashes until three new AA alkaline batteries are installed. If the batteries become too weak for normal operation, the thermostat enters the second battery power shortage mode.

When no battery power is left, the BATTERIES USED UP warning flashes on the display and the system turns off. The system remains off until new batteries are installed. The thermostat resumes normal operation after new batteries are installed.

---

## ***AUTO RECOVERY***

The AUTO RECOVERY FUNCTION allows heating and cooling systems to gradually recover from an energy-saving set point temperature to a comfort set point temperature. AUTO RECOVERY calculates the time needed to adjust the temperature to the next program setting. When the thermostat is in AUTO RECOVERY mode, the display flashes alternatively SYSTEM IN AUTO RECOVERY and the weekday.





NOTE: AUTO RECOVERY does not operate if Permanent or Temporary Holds are on.

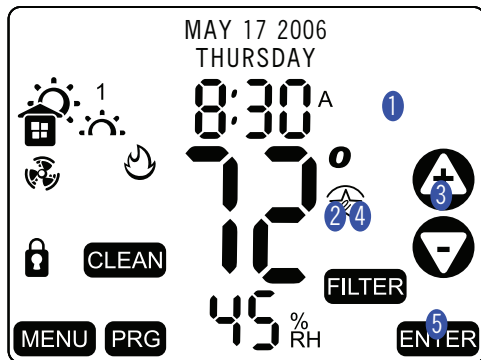

## ENERGY MONITOR FUNCTION

The ENERGY MONITOR function allows you to review and monitor the effect of your program settings on the system runtime.



- 
1. Touch a blank area of the touch screen.
  2. Touch the  icon.
  3. Scroll through the SYSTEM RUNTIME settings with the  or  sign to see the system runtime in hours for TODAY, YESTERDAY, the CURRENT MONTH or the LAST MONTH.
  4. Touch and hold the  icon for 3 seconds to reset the counters.
  5. Touch **ENTER** to return to the main screen.

---

## ***ERROR MESSAGE***

ERROR mode indicates an expected operation problem. The screen flashes a SYSTEM ERROR message and shuts the system off. You must reset and the thermostat by replacing the batteries if the thermostat has entered ERROR mode.

## ***AUTO CUT-OFF***

AUTO CUT OFF automatically turns the system off if the temperature rises above 95°F (35°C) or drops below 40°F (4°C).

NOTE: If the HVAC system has malfunctioned, the systems no longer respond to the thermostat controls and the AUTO CUT OFF will have no effect.

---

### ***COMPRESSOR PROTECTION***

After the system stops running in cooling mode, there is a 3.5 minute delay before it can be restarted to prevent compressor damage due to rapid cycling.

### ***RESETTING THE UNIT***

To restore the thermostat to the original factory settings, enter the SYSTEM SETTINGS MENU and set Option 12 to YES. See page 27.

---

## **TROUBLESHOOTING**

1. My display does not appear.
  - 1a. Check the batteries and battery connections.
  - 1b. Reset the thermostat.
2. The auto fan feature does not operate properly.
  - 2a. Check to see if the correct furnace type is selected under the system settings in options.
3. My display is erratic.
  - 3a. Replace the batteries.
4. The program will not change at my desired setting.
  - 4a. Check that the time is set properly to AM and PM.
  - 4b. Make sure the thermostat is not in permanent override mode.
  - 4c. Check that the day setting is correct.

- 
5. The heating or cooling will not turn on or off.
    - 5a. Make sure the thermostat is not in permanent override mode.
    - 5b. Wait. There may be as much as a 4-minute delay before the system turns on or off to protect the compressor.
    - 5c. Check circuit breakers and switches to ensure there is enough power to the system.
    - 5d. Replace batteries.
    - 5e. If applicable, make sure the furnace blower door is closed properly.
    - 5f. If your system has 4 wires, ensure the jumper is installed between the RC and RH terminals.
  6. The display comes on but does not stay illuminated.
    - 6a. Replace batteries.
  7. My system continues to operate when the thermostat is in the off position.
    - 7a. Replace unit.

- 
8. The touch screen permanently reads SYSTEM ERROR.
    - 8a. Refer to page 66 for ERROR mode instructions. If ERR message remains after battery replacement, then replace unit.
  9. How do I just operate my thermostat manually?
    - 9a. Manual operation instructions begin on page 38.

---

***NEED MORE HELP?***

Is there help on the web?

Yes, visit us at <http://www.climateproducts.com> for more information.

Is there someone I can call?

Yes. The CTC Technical Support is available from 7 am to 7 pm CST M-F and 8 am to 5 pm Saturday. They may be reached toll-free at 1-800-676-7861.



---

## WIRING DIAGRAMS

Number of wires connected depends on the HVAC system requirement.

- 4-wire Heat/Cool System (single stage): RH (jumper between RH and Rc/R), Y1, W1, G
- 5-wire Heat/Cool System (single stage): RH, Rc/R (remove jumper between RH and RC/R), Y1, W1 G.
- 2-wire Heat only (single stage): RH (jumper between RH and Rc/R), W1
- 3-wire Heat only (single stage): RH (jumper between RH and Rc/R), W1, G
- 3-wire Cool only (single stage): RH (jumper between RH and Rc/R), Y1, G

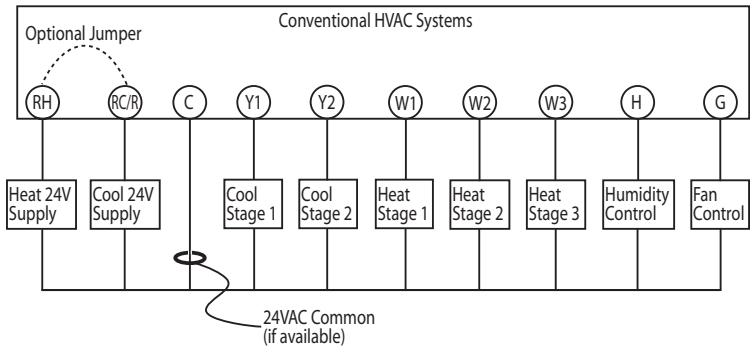

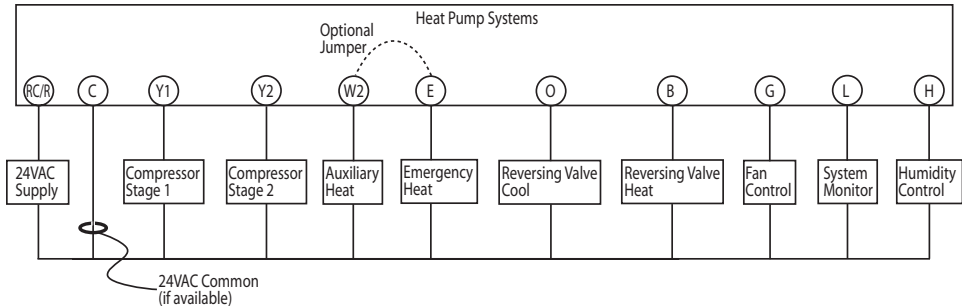

Number of wires connected depends on the heat pump system requirement. Not all terminals need to be connected.

- Add jumper between W2 and E terminals on systems without an E wire.

