

FAILURE TO READ AND FOLLOW ALL INSTRUCTIONS CAREFULLY BEFORE INSTALLING OR OPERATING THIS CONTROL COULD CAUSE PERSONAL INJURY AND/OR PROPERTY DAMAGE.

APPLICATIONS

Configuration Options	Applications	Maximum Stages
Single Stage	Gas, Oil, Electric, Heat Only, Cool Only or Heat Cool Systems	1/1
Multi Stage	Gas, Oil, Electric, Heat Only, Cool Only or Heat Cool Systems	2/2
Heat Pump	Single or Two Compressor Systems with up to 2 Stages of Aux / Em Heat	4/2
Heat Pump with Dual Fuel	Single or Two Compressor Systems with up to 2 Stages of Fossil fuel Heat	4/2

1F98EZ-1421, -1441 System

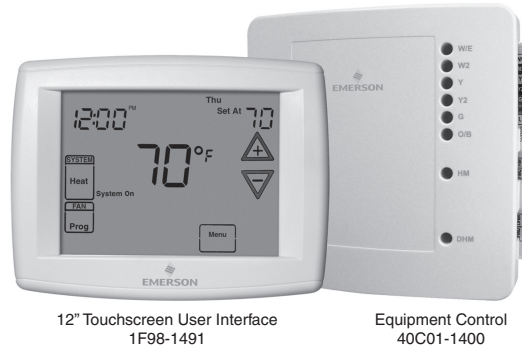

12" Touchscreen User Interface
1F98-1491

Equipment Control
40C01-1400

SPECIFICATIONS

Electrical Rating:

Input-Hardwire	20 to 30 VAC
Terminal Load	1.0A per terminal, 2.5A maximum all terminals combined
Setpoint Range	45° to 99°F (7° to 37°C)
Differential (Single Stage)	Heat 0.6°F; Cool 1.2°F
Differential (Multi-Stage)	Heat 0.6°F; Cool 1.2°F
Differential (Heat Pump)	Heat 1.2°F; Cool 1.5°F
Operating Ambient	32°F to +105°F (0° to +41°C)
Operating Humidity	90% non-condensing max.
Shipping Temperature Range	-40° to +150°F (-40° to +65°C)
Dimensions Interface	4-1/2"H x 6"W x 1-1/4"D
Dimensions Control	5-1/2"H x 5-3/4"W x 1-1/2"D

CAUTION

To prevent electrical shock and/or equipment damage, disconnect electric power to system at main fuse or circuit breaker box until installation is complete.

ATTENTION: MERCURY NOTICE

This product does not contain mercury. However, this product may replace a product that contains mercury.

Mercury and products containing mercury must not be discarded in household trash. Do not touch any spilled mercury. Wearing non-absorbent gloves, clean up any spilled mercury and place in a sealed container. For proper disposal of a product containing mercury or a sealed container of spilled mercury, place it in a suitable shipping container. Refer to www.white-roddgers.com for location to send product containing mercury.

Index	Page
Installation	2
Wiring Connections	2
Wiring Diagrams	3
Installer Configuration Menu	5
Troubleshooting	8

INSTALLATION

⚠ WARNING

Thermostat installation and all components of the control system shall conform to Class II circuits per the NEC code.

Control 40C01-1400

Control can be mounted on wall or equipment. Control has four mounting holes. Wall anchors and screws are provided for mounting on drywall. Drill 3/16 hole for drywall mounting.

If mounting on equipment **Do Not Mount** inside HVAC equipment. Only mount on outside of HVAC equipment.

Thermostat / Interface 1F98-1491

- 1) Pull the thermostat / interface off the base. Forcing or prying on the thermostat will cause damage to the unit.
- 2) Place base over hole in wall and mark mounting hole locations on wall using base as a template.
- 3) Move base out of the way. Drill mounting holes. If you are using existing mounting holes and the holes drilled are too large and do not allow you to tighten base snugly, use plastic screw anchors to secure the base.
- 4) Fasten base snugly to wall using mounting holes and two mounting screws. Leveling is for appearance only and will not affect thermostat operation.
- 5) Connect wires to terminal block on base (see Figure 1).
- 6) Push excess wire into wall and plug hole with a fire resistant material (such as fiberglass insulation) to prevent drafts from affecting thermostat operation.
- 7) Carefully line the thermostat up with the base and snap into place.

WIRING CONNECTIONS

Refer to equipment manufacturers' instructions for specific system wiring information. After wiring, see CONFIGURATION section for proper thermostat configuration.

Connect wires as appropriate for HVAC systems (see wiring diagrams). To power control, connect the 24 V system hot to R terminal and common to C on left side of control labeled "Power". On initial power up the 7 segment LED on the

control will display E (for communication error) until interface is connected. With power supplied to control, it is normal for the green system LED to flash periodically.

With interface connected, the 7 segment LED will display C to indicate the two devices have initiated communication. C will disappear after approximately 30 seconds when communication is established.

BLUE EASY INSTALL INPUTS/OUTPUTS

Easy Install 40C01 Control Terminals	Operational / Functional	Easy Install 40C01 Control Terminals	Operational / Functional
R	24 VAC Transformer	DHM2	Dehumidification Relay / Connection
RC	24 VAC Cooling Transformer	DHM2 dip switch	Breaks systems 24 V to DHM making DHM1 / DHM2 a normally open "dry" contact
RH	24 VAC Heating Transformer	HM	Humidification Relay / Connection
C	24 V Transformer Common	HM1 dip switch	Breaks systems 24 V to HM making HM1 / HM2 a normally open "dry" contact
W/E	Heating Stage 1 HP Aux/Em Heat Stage 1	R	24 VAC to Interface
W2	Heating Stage 2 HP Aux/Em Heat Stage 2	1	Data to/from Interface
Y	Compressor Stage 1	2	Data to/from Interface
Y2	Compressor Stage 2	C	24 VAC Common to Interface
G	Fan Relay	RJ11	Field configuration hook-up with RJ11 equipped configuration tool
L Terminal	System Monitor Compatible with Comfort Alert Diagnostics	+	Voltage to Outdoor Sensor
O/B Terminal	Changeover Relay Heat Pump	S	Outdoor Sensor Temperature Signal
DHM	Dehumidification Relay / Connection	-	Voltage to Outdoor Sensor

Fig. 1 - Thermostat / Interface to control wiring

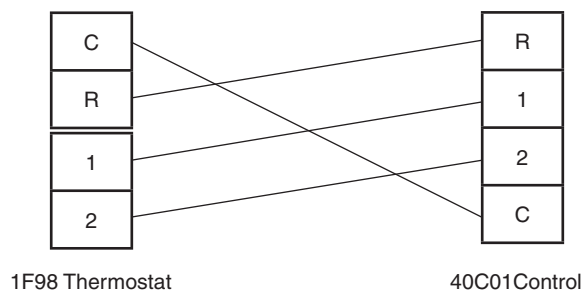

WIRING DIAGRAMS

Fig. 2 - Typical Connection of a Single Stage or Multi-Stage System

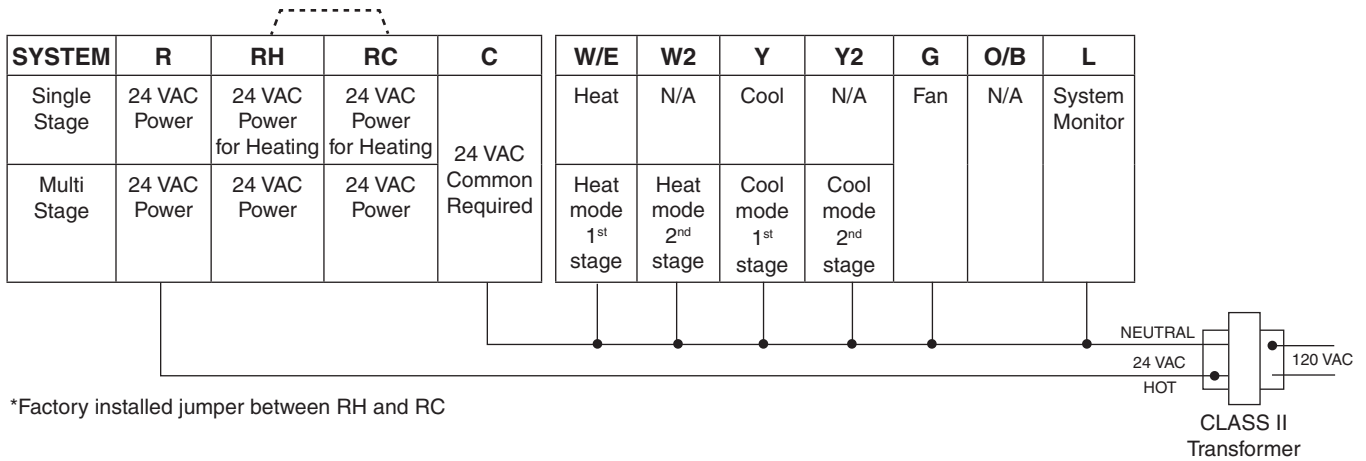

Fig. 3 - Typical Connection of Heat Pump System up to 4 Stages Heat / 2 Stages Cool

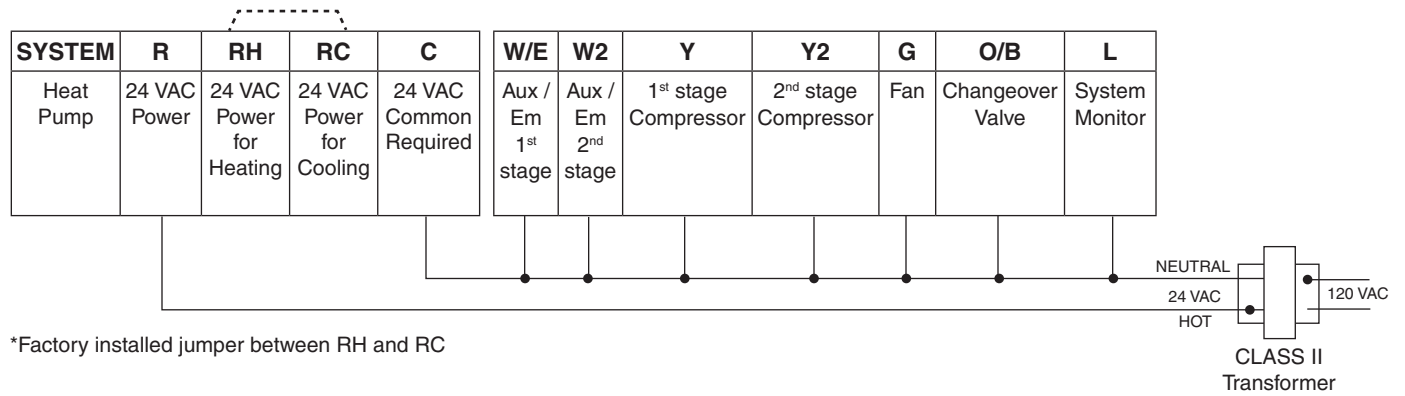
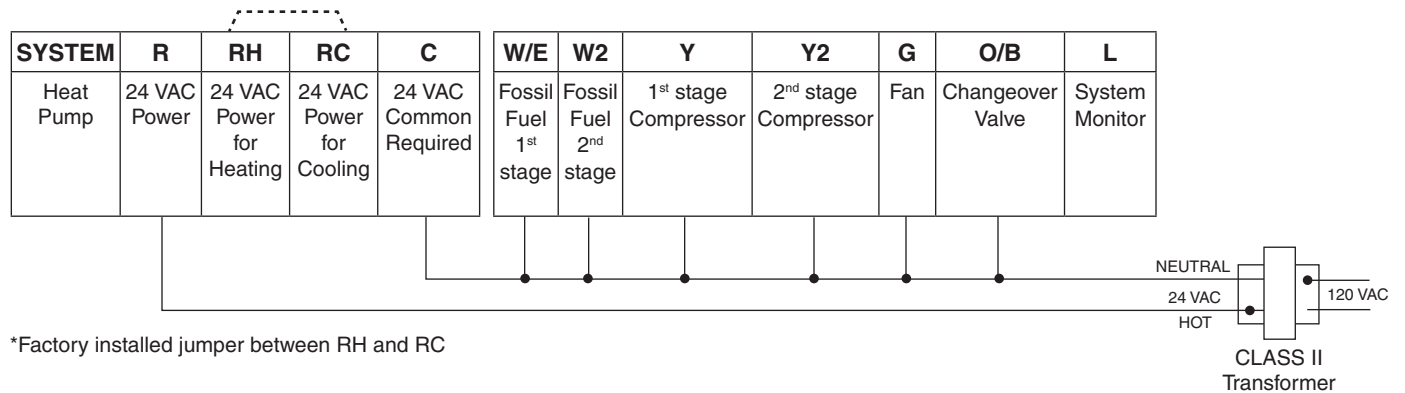

Fig. 4 - Typical Connection of Heat Pump / Dual Fuel System up to 4 Stages Heat / 2 Stages Cool



WIRING DIAGRAMS

Wiring Guide for Equipment Accessories

Fig. 5 - Non-Powered Humidifier. HM terminal provides 24 V on call for humidification

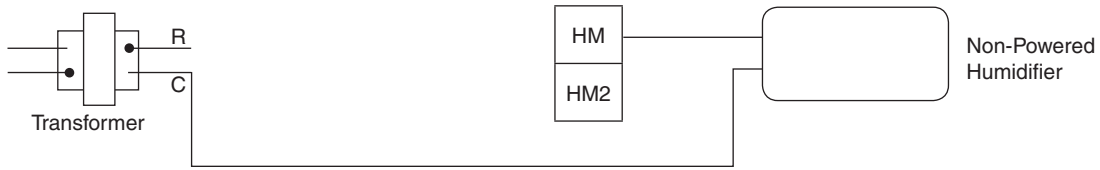

Fig. 6 - Powered Humidifier. With HM2 switch in DRY position HM and HM2 provide normally open dry contact for low voltage (24 V) powered humidifier connection.

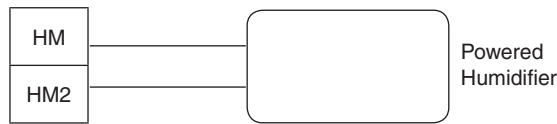

Fig. 7 - Powered Dehumidifier. With DHM2 switch in DRY position DHM and DHM2 provide normally open dry contact for low voltage (24 V) whole house powered dehumidifier connection.

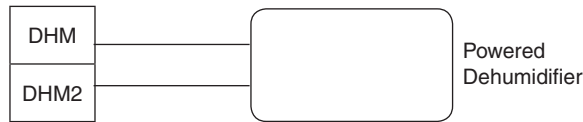

Fig. 8 - System Dehumidification with variable speed blower. For systems where low speed requires connect to normally open 24 V powered DHM terminal for low speed connection on air handler / furnace (24 V removed on dehumidification call).

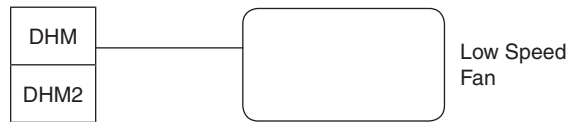
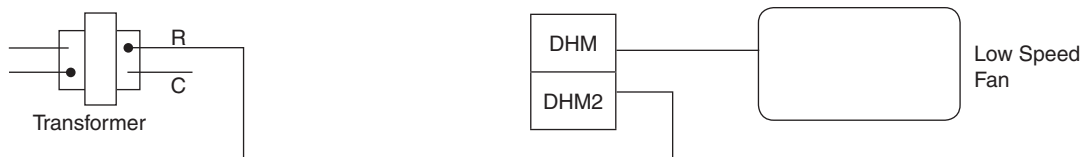





Fig. 9 - System Dehumidification with variable speed blower. For systems where low speed requires 24 V on dehumidification connect 24 V to DHM2 put DHM2 switch in DRY position and connect DHM to low speed connection on air handler/ furnace“



INSTALLER/CONFIGURATION MENU

Entering and Navigating the Advanced Installer Configuration Menu

On the Home Screen Display, touch the **Menu** key to display additional key choices. Touch and hold the **Installer Config** key for approximately 3 seconds to enter the Thermostat Options Configuration Menu. Touch and hold the **Installer Config** key again for approximately 3 seconds to enter the Advanced Installer Configuration Menu.

Ref. #	Description of Features in order when using  to choose; (Use  to step back)	Press  or  Key to Select Options		Displayed in Message Display
		Displayed in Clock Digits (Default)	Options	
1	Outdoor / Condensor Configuration	AC1	AC0, AC1, AC2, HP1, HP2	<i>CONDENSOR CONFIG</i>
2	Indoor Heat Configuration	GA2	FAN, GA1, GA2, EL1, EL2	<i>INDOOR HEAT CONFIG</i>
3	B or O terminal (HP1, HP2 only)	O	O, b	<i>REVERSING VALVE</i>
4	Heat Cycle Rate	FA	SL, FA	<i>HEAT CYCLE RATE</i>
5	Cool Cycle Rate	FA	SL, FA	<i>COOL CYCLE RATE</i>
6	Auxiliary Cycle Rate (HP1, HP2 only)	FA	SL, FA	<i>AUXILIARY CYCLE RATE</i>
7	Energy Management Recovery	On	OFF, On	<i>ENERGY MANAGEMENT RECOVERY</i>
8	Outdoor Remote Sensor	OFF	OFF, On	<i>OUTDOOR REMOTE SENSOR</i>
9	Auxiliary Off (HP1, HP2 only)	OFF	OFF, 35-80 (in steps of 1 degree) From OFF , value changes to 80	<i>AUXILIARY OFF</i>
10	Dual Fuel Config (HP1, HP2 only)	40	OFF, 0 to 50 (in steps of 1 degree) From OFF , value changes to 40	<i>DUAL FUEL CONFIG</i>
11	Dehumidification	OFF	OFF, 40-80 (in 1% steps) - displayed in the last digits of the Message Area. From OFF , value changes to 60	<i>DEHUM XX% (where XX is the DEHUM set point)</i>
12	Independent Dehumidification	OFF	OFF, On	<i>INDEPENDENT DEHUMID</i>
13	Humidification	OFF	OFF, 20-60 (in 1% steps) - displayed in the last digits of the Message Area. From OFF , value changes to 40	<i>HUMID XX% (where XX is the HUM set point)</i>
14	Independent Humidification	OFF	OFF, On	<i>INDEPENDENT HUMID</i>
15	Compressor	OFF	OFF, On	<i>COMPRESSOR</i>

INSTALLER/CONFIGURATION MENU

Configuration

Control can be configured at the equipment by utilizing the configuration plug in tool (F4-1400). The tool mounts to the back of the interface and plugs into the bottom of the control via the RJ-11 connection. (Note you cannot have two interfaces connected to the control at the same time). With control powered, interface is used to configure the application and for operational checks. Once configured, the interface can be installed in living area.

- 1) **Outdoor / Condenser Configuration.** Select the number type A/C (air conditioner) HP heat Pump and number of stages. The appropriate Color (A/C= Amber, Heat Pump=Green) LED will illuminate for the configured Y / Y2 terminals.
- 2) **Indoor / Heat Configuration.** Select the number type GA (Gas) EL (electric) and Fan and number of stages. The appropriate Color (Amber if gas, Green if electric) LED will illuminate for the configured W / W2 terminals.
- 3) **B or O Terminal Configuration.** If condenser is heat pump configured then Select either O (default) or B terminal output configuration. The B/O LED will illuminate the appropriate color (Amber if O, Green if B)
- 4) **Heat Cycle Rate.** Select either FA fast (default) or SL slow cycle rate. If longer cycles are desired then set to SL.
- 5) **Cool Cycle Rate.** Select either FA fast (default) or SL slow cycle rate. If longer cycles are desired then set to SL.
- 6) **Auxiliary Cycle Rate.** If condenser is heat pump select either FA fast (default) or SL slow cycle rate. If longer cycles are desired then set to SL.
- 7) **Energy Management Recovery.** Select either On or Off. With a selection of On the system will start temperature setback recovery early to reach the program setpoint at the program start time. A selection of Off will start the recovery period at the program start time.
- 8) **Outdoor Remote Sense.** A selection of On enables the display of outdoor temperature with the connection of F145-1378 outdoor remote sensor to the control.
- 9) **Auxiliary Off.** When condenser is heat pump configured and outdoor sensor is connected, the option of locking out the auxiliary heat based on outdoor ambient temperature becomes available. Default is off with a selection range from 80 degrees to 35 degrees in 1 degree increments. When outdoor ambient is above the selected temperature the auxiliary stages are disabled.
- 10) **Dual Fuel Config.** When condenser is heat pump and indoor heat is gas and outdoor sensor is connected. A selection from 0 to 50 in one degree increments is available. The Auxiliary / fossil fuel system is enable the heat pump is disabled when the outdoor ambient temperature is at or below the selection.
- 11) **Dehumidification.** Select from Off (default) to a setting range from 40% to 80% Rh. If Rh is above setting a cooling call is initiated. To turn this feature Off raise setting to it highest level 80%
- 12) **Independent Dehumidification.** Selection of Off (default) or On. When On is selected the DHM2 output is active when humidity level is above the desired dehumidification setting.
- 13) **Humidification.** Select from Off (default) to a setting range from 20% to 60% Rh. If Rh is below setting HM2 output is active with a call for heat. To turn this feature Off lower setting to it lowest level 20%.
- 14) **Independent Humidification.** Selection of Off (default) or On. When On is selected the HM2 output operates when humidity level is below the desired humidification setting.
- 15) **Compressor Lockout.** Selection of Off (default) or On. When On is selected the control will invoke a 5 minute delay between compressor cycles.

After Advanced Installer Configuration, LEDs on the control will indicate the selections of the thermostat. The following tables show the LED indications. Remove control cover to

view LEDs. To view LEDs with cover installed, break off tab on inside of cover.

Fig. 10 - LED locations

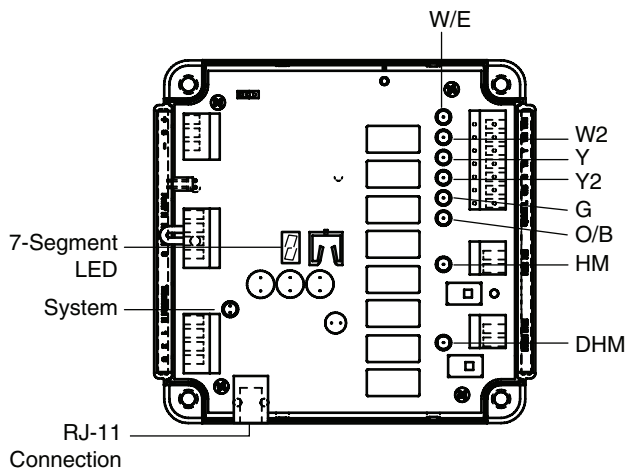
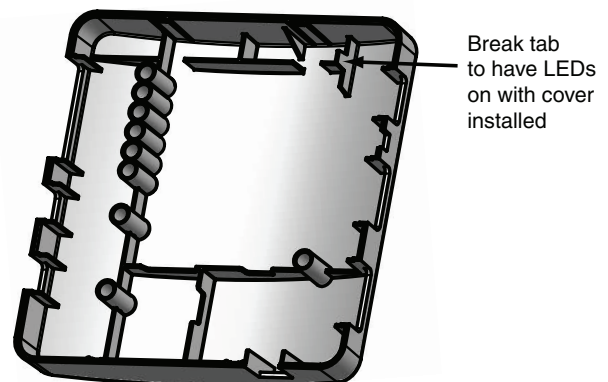

Fig. 11 - Inside of front cover



INSTALLER/CONFIGURATION MENU

LED Indicator legend:

 = Amber  = Green  = Off

Table 1 - System Configuration

System Type	Outdoor Equipment Type	No. of Stages – Outdoor Equipment Type	Indoor Equipment Type	No. of Stages – Indoor Equipment Type	Y	Y2	W/E	W2	G
Conventional	AC	1	Gas	1		Off		Off	
	AC	1	Gas	2		Off			
	AC	2	Gas	1				Off	
	AC	2	Gas	2					
Heat Pump	HP	1	Elec	2		Off		Off	
	HP	1	Elec	1		Off			
	HP	2	Elec	2					
	HP	2	Elec	1					
Dual Fuel	HP	1	Gas	2		Off			
	HP	1	Gas	1		Off			
	HP	2	Gas	2					
	HP	2	Gas	0					
AC Cool	AC	1	Elec	0		Off	Off	Off	
	AC	2	Elec	0			Off	Off	
Gas Heat	No Outdoor Unit	–	Gas	1	Off	Off		Off	
	No Outdoor Unit	–	Gas	2	Off	Off			
Electric Heat	No Outdoor Unit	–	Elec	1	Off	Off		Off	
	No Outdoor Unit	–	Elec	2	Off	Off			
Electric System	AC	1	Elec	1		Off		Off	
	AC	1	Elec	2		Off			
	AC	2	Elec	1				Off	
	AC	2	Elec	2					
HP Only (HO)	HP	1	Elec	0		Off	Off	Off	
	HP	2	Elec	0			Off	Off	
Fan Only	No Outdoor Unit	–	Elec	0	Off	Off	Off	Off	

Table 2 - DHM Bi – Color LED Table

Switch Position	DHM LED
RH	
DHM2	

Table 3 - HM Bi – Color LED Truth Table

Switch Position	HM LED
RH	
HM2	

Table 4 - O/B Bi Color LED Truth Table



Reversing Valve Configuration	O/B LED
B mode	
O mode	

TROUBLESHOOTING

Reset Operation

If a voltage spike or static discharge blanks out the display or causes erratic thermostat operation, you can reset the system by removing batteries for 2 minutes. After resetting the system, replace the batteries. If the system has been reset and still does not function correctly perform a power reset.

Note: Be sure to review the installer configuration menu settings.

Note: When thermostat is reset, installer configuration menu settings and programming will reset to factory settings. To reset the programming, clock and configuration settings, press  and  and the SYSTEM touch keys simultaneously. The thermostat should go blank and then all segments will be displayed momentarily.

Symptom	Possible Cause	Correction Action
No Heat/No Cool/No Fan (common problems)	<ol style="list-style-type: none"> Blown fuse or tripped circuit breaker. Power switch to OFF. Furnace blower compartment door or panel loose or not properly installed. Loose connection to system. 	Replace fuse or reset breaker. Turn switch to ON. Replace door panel in proper position to engage safety interlock or door switch. Check connections.
No Heat	<ol style="list-style-type: none"> Pilot light not lit. Furnace Lock-Out Condition. Heat may also be intermittent. Heat pump system requires service. See fault code table ComfortAlert. 	Re-light pilot. Many furnaces have safety devices that shut down when a lock-out condition occurs. If the heat works intermittently contact the furnace manufacturer or local HVAC service person for assistance.
No Cool	<ol style="list-style-type: none"> Cooling system requires service. See fault code table ComfortAlert. 	
Heat, Cool or Fan Runs Constantly	<ol style="list-style-type: none"> Possible short in wiring. Possible short in thermostat. Possible short in heat/cool/fan system. FAN Switch set to Fan ON. 	Check each wire connection to verify they are not shorted or touching together. No bare wire should stick out from under terminal block. Try resetting the thermostat as described above. If the condition persists the manufacturer of your system or service person can instruct you on how to test the Heat/Cool system for correct operation. If the system operates correctly, replace the thermostat.
Thermostat Setting & Thermostat Thermometer Disagree	<ol style="list-style-type: none"> Thermostat display setting requires adjustment. 	The display can be adjusted +/- 5 degrees. See Temperature Display Adjustment in the Configuration Menu section.
Furnace (Air Conditioner) Cycles Too Fast or Too Slow (narrow or wide temperature swing)	<ol style="list-style-type: none"> The location of the thermostat and/or the size of the Heating System may be influencing the cycle rate. 	Digital thermostats provide precise control and cycle faster than older mechanical models. The system turns on and off more frequently but runs for a shorter time so there is no increase in energy use. If you would like an increased cycle time, choose SL for slow cycle in the Configuration menu.

Comfort Alert™ Fault Codes

Number Displayed in 7 Segment LED	Comfort Alert Fault
0	Trip
1	Long Run Time
2	System Pressure Trip
4	Short Cycling
5	Locked Rotor
6	Open Start Circuit
7	Open Run Circuit
8	Welded Contactor
9	Low Voltage

White-Rodgers is a division of Emerson Electric Co.

The Emerson logo is a trademark and service mark of Emerson Electric Co.

White
Rodgers™

www.white-rodgers.com
www.emersonclimate.com

EMERSON
 Climate Technologies