

Safety, Installation, and Operation Manual

READ COMPLETE INSTALLATION INSTRUCTIONS BEFORE STARTING.

WARNING

This product must be installed by a qualified heating and air conditioning contractor. Failure to do so could result in serious injury from electrical shock or damage to product and voids product warranty due to possible product misapplication.

THESE INSTALLATION INSTRUCTIONS ARE FOR THE AUTOMATIC STEAM HUMIDIFIER CONTROL ONLY!

For Aprilaire® Humidifier installation, follow Aprilaire Humidifier Installation Instructions.

WARNING

1. 240 volts may cause serious injury from electrical shock. Disconnect electrical power to the Steam Humidifier before starting installation.
2. Sharp edges may cause serious injury from cuts. Use care when cutting plenum openings and handling ductwork.

CAUTION

1. Do not set humidity higher than recommended. Condensation damage may result.
2. Do not set humidity up to recommended levels if there is condensation on the inside of windows. Condensation damage may result.
3. Do not mount Automatic Steam Humidifier Control on supply plenum or duct. High supply temperatures will cause the control to malfunction.
4. When installing Automatic Steam Humidifier Control on downflow furnaces, ensure blower continues to run after a heat call is satisfied to eliminate high temperatures from damaging the Automatic Steam Humidifier Control.
5. Do not configure Automatic Steam Humidifier Control for Modulating Control (jumper JP2 set to 1 & 2) when connected to a Model 1150 Steam Humidifier. Failure of humidifier may result.

PRINCIPLES OF OPERATION

The Aprilaire Automatic Steam Humidifier Control is designed to be installed in the return duct of the HVAC system. The control strategy of the Automatic Steam Humidifier Control is matched to the humidifier being controlled: when used with a Model 1150 Aprilaire Steam Humidifier, the Control supplies an on/off signal to the humidifier. When used with a Model 1160 Aprilaire Steam Humidifier, the Control supplies a modulating signal to the humidifier. In terms of outdoor temperature compensation, the Control can be set up in automatic or manual mode, regardless of the humidifier model being controlled. The automatic mode incorporates the supplied Outdoor Temperature Sensor to automatically adjust the control set-point based on the outdoor temperature. The manual mode does not require an outdoor temperature measurement and is used for specific set-point control with the control set-point manually adjusted by the user. The Automatic Steam Humidifier Control will accurately control the humidity in the conditioned space within the range of 15% – 55% RH.

CONTROL TYPE

ON/OFF CONTROL FOR MODEL 1150

The Automatic Steam Humidifier Control sends a 10 VDC signal to the humidifier when the measured return air relative humidity is 3% or more below the set-point. This energizes the humidifier at 100% output. The Steam Humidifier is either on at 100% capacity or it is off.

MODULATING CONTROL FOR MODEL 1160

The Automatic Steam Humidifier Control sends a signal to the humidifier between 0 and 10 VDC based on: a) the difference between measured relative humidity and set-point relative humidity, and b) where this difference or 'error' falls within an adjustable proportional control band. The output of the Control, and therefore the Steam Humidifier, is a 'proportion' of maximum output based on 'a' and 'b' above. See **Figure 1** for graphical representation of the output.

FIGURE 1 – Modulating Control Output

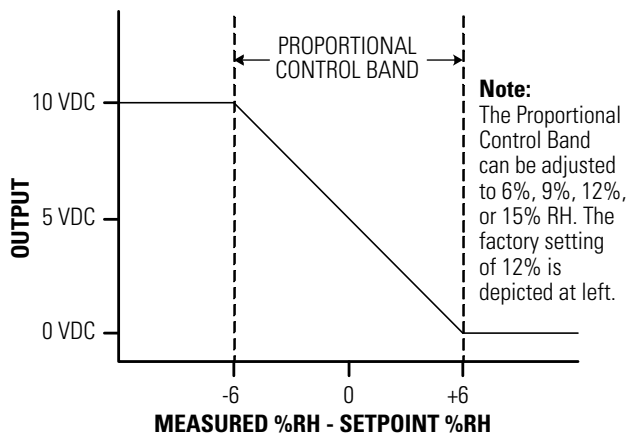

As an example, using the 12% proportional band (factory-setting), when the measured RH is 6% above the set-point the output will be 0 VDC; when the measured RH is 6% below set-point the output will be 10 VDC; when the measured RH is 3% below set-point the output will be approximately 7.5 VDC. The humidifier uses this varying signal to time-proportion the operation of the heating elements in the tank. 10 VDC output corresponds with 100% humidifier capacity, 5 VDC with 50% capacity, etc. Modulating control will result in a more precise control of relative humidity.

OUTDOOR TEMPERATURE COMPENSATION

AUTOMATIC MODE

The automatic mode is the preferred method when the application requires that the Control automatically adjust the RH set-point based on the outdoor temperature. This is recommended for all comfort-based applications such as office buildings, schools, day cares, etc. It is also recommended for any application where the primary concern is to avoid the potential for condensation that can form on areas within the building such as windows and within walls. When installed in this mode, the Control utilizes an Outdoor Temperature Sensor that will track the actual outdoor temperature. The Control then automatically adjusts the desired indoor RH.

MANUAL MODE (SPECIFIC SET-POINT CONTROL)

The manual mode is the preferred method when the application requires that a specific set-point be maintained regardless of the outdoor temperature. This is recommended for all process-based applications such as print shops, book stores, test facilities, etc.

When installed in this mode, the Outdoor Temperature Sensor is replaced with a “manual” resistor case that prevents the Control from adjusting the space RH set-point based on the outdoor temperature, and controls to the specific set-point selected on the Control.

Note: If the building is not designed to handle the amount of RH the humidifier is supplying, the building occupants may need to adjust the RH setting on the Control to a lower value during extreme days to prevent condensation on interior surfaces. The RH setting should be adjusted upward when the outdoor temperature goes up.

INSTALLATION

CAUTION

Improper jumper settings may damage humidifier.

The shunt on the JP2 header pin must be set in accordance with the instructions in this manual.

STEP 1: VERIFY CONTROL TYPE

When shipped with a Steam Humidifier, the Automatic Steam Humidifier Control is preset at the factory to match the humidifier model: Model 1150 Steam Humidifier is configured for on/off control while the Model 1160 Steam Humidifier is configured for modulating control. When shipped as a replacement (Model 57), the Control is preset for use with a Model 1150 (i.e., on/off control). If using the Model 57 with a Model 1160, the ‘control type’ setting must be changed for modulating control. See below.

Remove the door to the Automatic Steam Humidifier Control and look at the area on the circuit board above the terminal block. The three-pin header labeled **JP2** should be set in the following manner:

For the Model 1150, the Control must be set to the on/off configuration. The shunt must be placed on the 2 & 3 pins. See **Figure 2**.

FIGURE 2 – On/Off Setting for Model 1150

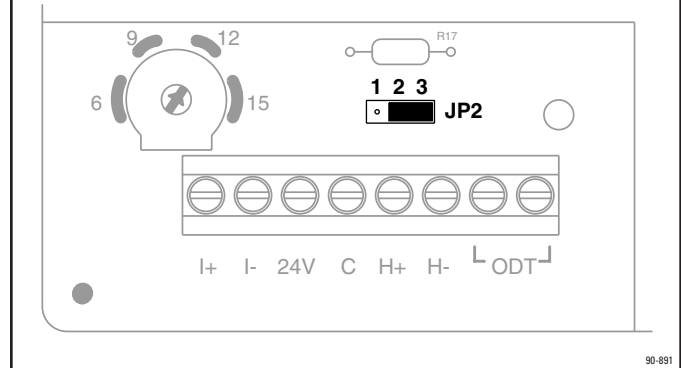

For the Model 1160, the Control must be set to the modulating configuration. The shunt must be placed on the 1 & 2 pins. See **Figure 3**.

FIGURE 3 – Modulating Setting for Model 1160

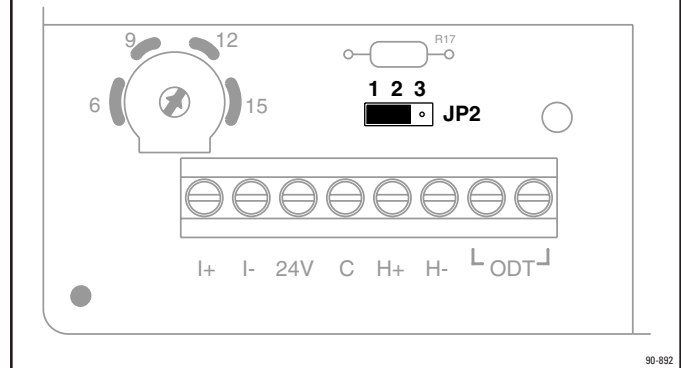

STEP 2: DETERMINE LOCATION FOR CONTROL AND MOUNT ON DUCT

The Control must be mounted in the return duct of the HVAC system. See **Figure 4** for a split-system installation and **Figure 5** for a rooftop unit installation. The Control must be at least 1 foot upstream of the steam dispersion tube and any fresh air intake ductwork. Use the template in the back of this manual to mark the duct opening. After cutting the hole in the duct, mount the Control tightly to the duct using 4 sheet metal screws (not provided).

FIGURE 4 – Split System Installation

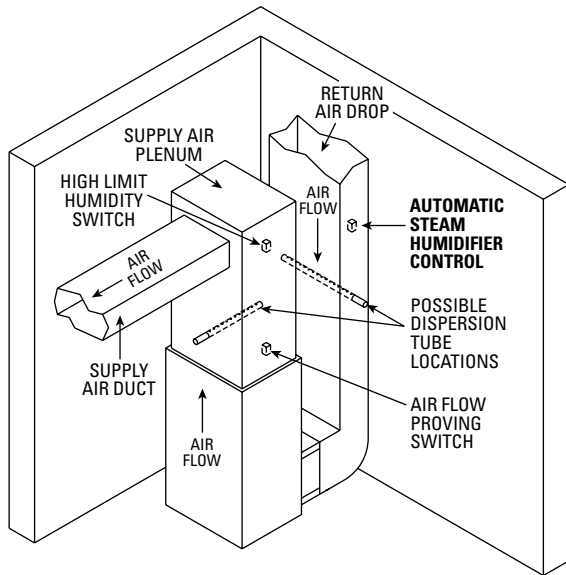

90-893

FIGURE 5 – Rooftop Unit Installation

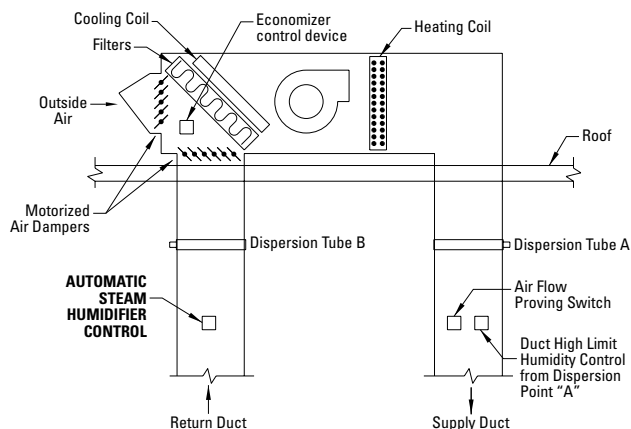

90-894

STEP 3: DETERMINE LOCATION FOR OUTDOOR TEMPERATURE SENSOR

The location of the Outdoor Temperature Sensor must meet these three requirements:

1. Must be mounted on North, East or West side of building out of direct sunlight
2. Must be at least 3 feet from all exhaust vents
3. Must be above expected snow line (See **Figure 6**)

Incorrect humidity levels will result if these requirements are not met. Attach the sensor bracket to the building with a #8 galvanized screw.

FIGURE 6 – Outdoor Temperature Sensor Location

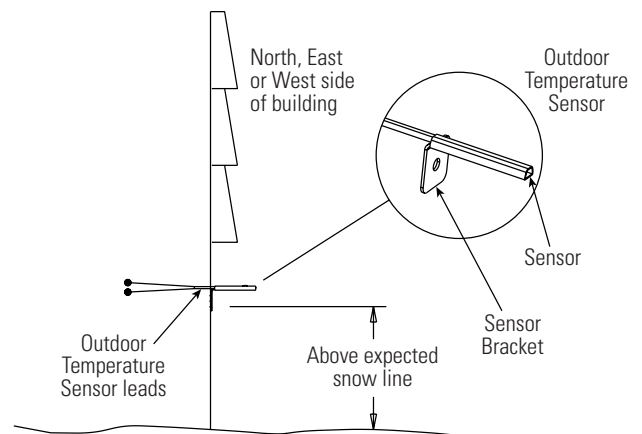

90-895

STEP 4: LOCATE ACCESS HOLE FOR WIRING TO OUTSIDE SENSOR

Look for or provide an opening in the building envelope for running wire to the Sensor. A convenient way to get wire to the Sensor is to make use of unused wires running to the A/C condensing unit (if applicable). Other ways are to use existing holes for telephone lines, A/C lines, water meter, etc. Read all equipment instructions beforehand for possible conflicts and warnings. **Do not run outdoor temperature sensor wiring alongside wires carrying high voltage (120VAC or higher).**

STEP 5: ALTERNATE LOCATION FOR OUTDOOR TEMPERATURE SENSOR

The Sensor can also be mounted in the center of either:

- PVC fresh air intake pipe for the split system furnace
- OR**
- Fresh air intake duct. Mount the sensor with a #8 galvanized screw.

In both cases, the Sensor must be no more than 3 feet from the outside wall. See Figure 7.

If it is not feasible to use the Outdoor Temperature Sensor in any of the ways described, the Automatic Steam Humidifier Control can be set for Manual Operation. See **Figure 8** on the next page for details.

FIGURE 7 – Alternate Location for Outdoor Temperature Sensor

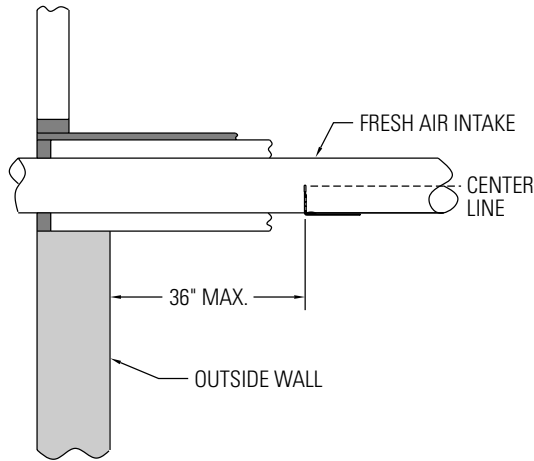

90-896

STEP 6: ROUTE THE WIRE TO CHOSEN SENSOR LOCATION

Run wire to the outdoor temperature sensor. Sensor is not affected by lead length up to 300 feet. Use standard thermostat wire. **Do not run outdoor temperature sensor alongside wires carrying high voltage (120 VAC or higher).**

STEP 7: ATTACH SENSOR WIRE TO AUTOMATIC STEAM HUMIDIFIER CONTROL

Strip wires 1/4 inch, and insert the wires from the Sensor into the terminals labeled "ODT" on the Automatic Steam Humidifier Control.

INSTALLING THE AUTOMATIC STEAM HUMIDIFIER CONTROL FOR MANUAL OPERATION

1. Insert the Manual Mode Resistor Case into the terminals labeled "ODT" on the Automatic Steam Humidifier Control.
2. Snap the Manual Mode Resistor Case into the slot provided so that Resistor Case sticks out from the bottom edge of the base.
3. Remove the control knob and apply the Manual Mode label to the cover, aligning the sticker and knob holes. Re-install the knob.

FIGURE 8 – Manual Mode

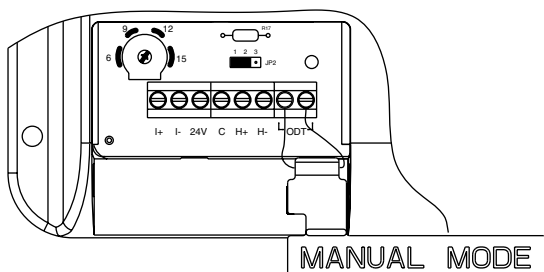

90-899

STEP 8: WIRE THE CONTROL TO THE HUMIDIFIER

Wire the Control to the field wiring terminal block of the Steam Humidifier according to **Figure 9**. Use 3-wire shielded cable with ground for the wiring from the Control to the Humidifier. Note the terminal designations below.

AUTOMATIC STEAM HUMIDIFIER CONTROL:

- I+, I-** Serial Communications (for optional devices)
- 24V** +24 VDC input power
- C** Common
- H+** Command Signal to Steam Humidifier
- H-** Command Signal to ground (not used)
- ODT** Outdoor Temperature Sensor

STEAM HUMIDIFIER:

- 30** +24 VDC output power
- C** Humidifier Common
- 1** Command Signal from Control

FIGURE 9 – Wiring Diagram

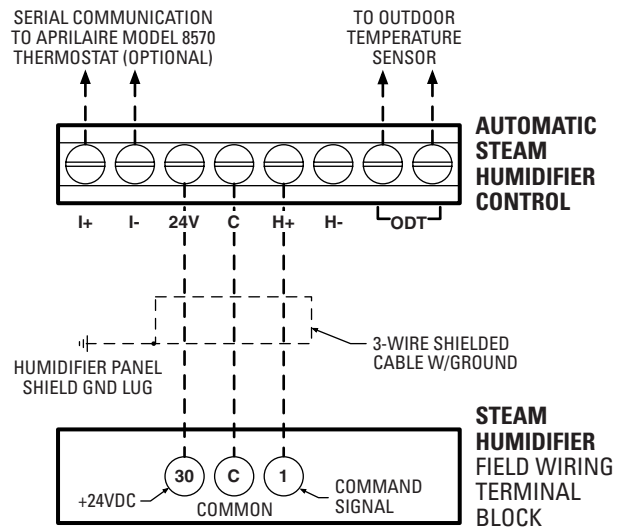

90-900

OPERATION

SYSTEM CHECKOUT

1. For system test, be sure that all Steam Humidifier plumbing, distribution, and electrical connections are set-up in accordance with the instructions in the Steam Humidifier Installation, Operation, and Maintenance Manual and all precautions therein are followed.
2. Turn on the water supply to the humidifier. Make sure the drain valve is closed.
3. Turn on power to the humidifier.
4. Set up a fan call at the thermostat. If the humidifier is configured to bring on the equipment fan when a demand for humidity is recognized, skip to the next step.
5. Initiate a humidity demand from the Control by rotating the control knob of the Automatic Steam Humidifier Control clockwise to the 'Test' position.

6. If all is set up properly, the 'Steam' indicator light on the humidifier will illuminate and the heaters will be energized. In the 'Test' position, the humidity demand will last for one minute.
7. If the 'Steam' indicator light does not illuminate when the Control is turned to the 'Test' position, refer to the troubleshooting section of this manual.
8. Setting the Control:
 - If using Automatic Mode and the conditioned space is occupied, set the Control to knob-setting 4.
 - For Manual Mode and the conditioned space is occupied, set to 35% or to a level that matches the application's needs.
 - If the conditioned space is unoccupied, set the Control to 'Off'

For information on the initial adjustment period, refer to the operation notes in the next section.

9. Make sure the Red Diagnostic Light on the Control (see **Figure 10**) is not lit. If the Red Diagnostic Light is lit, re-check the wiring. If the Red Diagnostic Light does not go off, refer to the troubleshooting section of this manual. Note that the Red Diagnostic Light will turn on momentarily when first powered up.

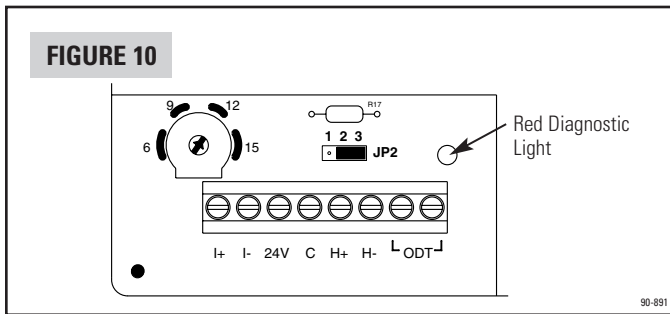

CAUTION

A high relative humidity setting on the Control may cause excessive condensation on windows and within walls. Set the relative humidity in accordance with the instructions in this manual. Do not set the relative humidity higher than recommended.

OPERATION NOTES FOR MODULATING CONTROL FOR MODEL 1160

As explained in the 'Principles of Operation' section of this manual, when configured for modulating control, the Automatic Steam Humidifier Control sends a 0-10V signal to the humidifier to vary the capacity of the Steam Humidifier depending on where the measured return air relative humidity falls relative to the set-point as well as the proportional control band. This will result in a more precise control of relative humidity.

The proportional control band can be set to 6%, 9%, 12%, or 15% RH. The factory-setting is 12%. Note that the proportional control band is centered on the RH set-point. Refer back to **Figure 1**. If the humidifier is cycling on and off too frequently, the proportional control band setting may need to be widened. To change, use a small flat-head screwdriver to rotate the potentiometer in the Automatic Steam Humidifier Control board. See **Figure 11**.

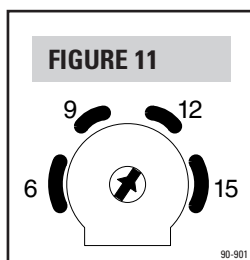

AUTOMATIC MODE OPERATION NOTES

The Automatic Steam Humidifier Control is installed in the return duct. During the first heating season, the Automatic Steam Humidifier Control needs to be adjusted to match the requirements and construction of the conditioned space. Please follow these steps when adjusting the Control (refer to **Figure 12**)

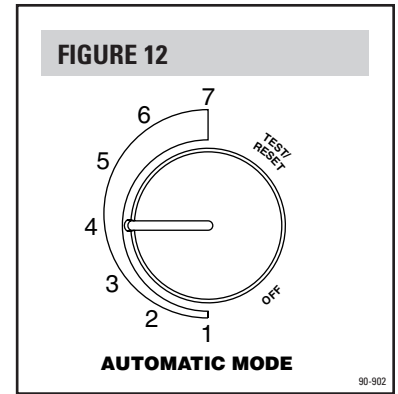

Turn the dial to a setting of "4". At this setting, when the Outdoor Temperature is 20°F, the indoor relative humidity set-point of the Automatic Steam Humidifier Control will be 35% RH. During the next 24-48 hours, it may be necessary to adjust the dial for more or less humidity, depending on the occupants' comfort and the requirements of the conditioned space. Refer to the 'Operation Guide' (**Table 1**).

During the coldest portion of the first heating season, minor adjustments may be necessary. This is dependent upon the unique features and construction of the conditioned space. Refer to the 'Operation Guide' (**Table 1**).

TABLE 1: Operation Guide

Condition	Solution
Condensation on windows.	Reduce the setting on the control dial by 1 increment.
Lack of humidity.	Increase the setting on the control dial by 1 increment.

The relative humidity in the conditioned space will now be accurately controlled and should need no further adjustment during future heating seasons. Make note of the dial setting in the event the knob is temporarily moved when performing annual maintenance of the Aprilaire Steam Humidifier.

Table 2 below shows the way the Automatic Steam Humidifier Control automatically adjusts the relative humidity based on the outdoor temperature. For example, when the knob is set to "4" and the outdoor temperature is 20°F, the conditioned space will be controlled to 35% RH.

TABLE 2: Relative Humidity Guide

		Outdoor Temperature (°F)							
		-20	-10	0	10	20	30	40	50
Dial Setting	1	-	-	-	10	15	20	25	30
	2	-	-	12	17	22	27	32	37
	3	-	13	18	23	28	33	38	43
	4	15	20	25	30	35	40	45	50
	5	22	27	32	37	42	47	52	55
	6	28	33	38	43	48	53	55	55
	7	35	40	45	50	55	55	55	55

MANUAL MODE OPERATION NOTES

The Automatic Steam Humidifier Control is installed in the return duct. When installed in the Manual Mode, the Control provides specific set-point control. If the building is not designed to handle the amount of RH the humidifier is supplying, the RH setting on the Control may need to be adjusted to a lower value during extreme days to prevent condensation on interior surfaces. For example, with an outdoor temperature of 20°F the correct setting will be 35% relative humidity. If the temperature is expected to fall to 0°, then reduce the setting to 25% several hours prior to the temperature change. It is important to adjust the RH setting upward when the outdoor temperature goes back up again.

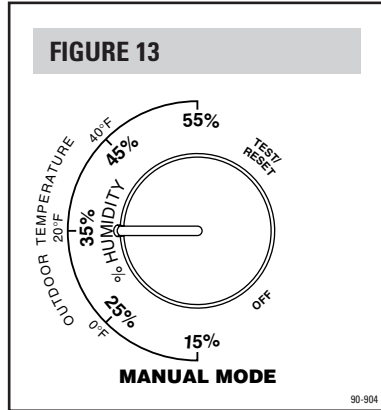

The recommended settings on the humidistat are based on years of research for an average building. (See *ASHRAE Handbook – HVAC Systems and Equipment*, Ch. 20 – Humidifiers.) Note: these settings may not be appropriate for every application. These settings represent a compromise between RH levels that would be most desirable for comfort reasons and humidity levels that are suitable for protection of the conditioned space and to avoid condensation on windows and within walls. For example, a wintertime indoor RH of 50% may be considered ideal for comfort, but unfortunately, it probably would result in damage to the conditioned space. Observance of the recommended RH levels on the humidistat, therefore, is an important safeguard. Condensation of water on inside windows in the form of fogging or frost is an indication of too much relative humidity. This same condensation can occur in other areas of the conditioned space with the possibility of damage resulting.

TABLE 3: Outdoor–Indoor Relative Humidity

Outside Temperature	Recommended RH
+40°F	45%
+30°F	40%
+20°F	35%
+10°F	30%
0°F	25%
-10°F	20%
-20°F	15%

TROUBLESHOOTING GUIDE

Applies to both Automatic and Manual Operation unless indicated otherwise.

SYMPTOM

TROUBLESHOOTING PROCEDURE

Humidifier does not operate in "Test" mode

- Make sure equipment blower is operating and thermostat is calling for heat.
- Make sure the Outdoor Temperature Sensor is connected to the "ODT" terminals of the control. (For Manual Operation, make sure Manual Mode Resistor Case is in place of the Sensor).
- Check main wiring diagram for correct Automatic Steam Humidifier Control installation.
- Check voltage at Automatic Steam Humidifier Control "24V" and "C" terminals. Voltage should be 22 VDC minimum – 26 VDC maximum.
- In "Test" mode, humidifier will operate for 1 minute only. **DO NOT LEAVE IN TEST MODE AS HUMIDIFIER WILL NOT OPERATE.**
- Make sure water supply valve is open.
- If humidifier still does not operate, refer to the Aprilaire Steam Humidifier Installation, Operation, and Maintenance Manual.

Humidifier operates only in "Test" mode

- If outdoor temperature is greater than 60°F or less than -30°F, the Automatic Steam Humidifier Control will only operate in the "Test" mode. (Automatic Mode Only)
- If the humidity level in the building is higher than the knob setting or the proportional control band (Model 1160 only), the Automatic Steam Humidifier Control will not operate the Humidifier.
- Check the resistance of the sensor by removing the leads of the Outdoor Temperature Sensor from the terminals and measuring the resistance across the wires with an ohmmeter. Confirm reading to outdoor temperature in **Table 4**. (For Manual Operation, remove leads and verify that resistance across the leads of Manual Mode Resistor Case is between 44,000 and 48,000 ohms).
- Make sure the Outdoor Temperature Sensor is mounted completely outside the building on the North, East, or West side of the building and out of direct sunlight. (Automatic Mode Only)
- If Outdoor Temperature Sensor is mounted in fresh air intake duct, make sure the probe is no more than 36 inches from the outside wall. (Automatic Mode Only)
- Make sure the Outdoor Temperature Sensor is located at least 3 feet away from all exhaust vents. (Automatic Mode Only)

TABLE 4

Outdoor Temperature	Resistance kΩ
-30°F	230.6
-20°F	163.8
-10°F	117.6
0°F	85.4
10°F	62.6
20°F	46.3
30°F	34.6
40°F	26.1
50°F	19.9
60°F	15.3
70°F	11.9
80°F	9.4
90°F	7.4
100°F	5.9

SYMPTOM**TROUBLESHOOTING PROCEDURE**

Humidifier operates constantly

- If the humidity level in the building is less than the knob setting or is within the proportional control band (Model 1160 only), the Automatic Steam Humidifier Control will operate the humidifier until the humidity level is higher than the knob setting.
- In the "Test" mode, verify unit will operate for approximately one minute.
- Check the resistance of the sensor by removing the wires of the Outdoor Temperature Sensor and measuring the resistance across the wires with an ohmmeter. Confirm reading to outdoor temperature in **Table 4**. (For Manual Operation, verify that resistance across the leads of Resistor Case is between 44,000 and 48,000 ohms.)
- Make sure the Outdoor Temperature Sensor is mounted completely outside the building on the North, East, or West side of the building and out of direct sunlight. (Automatic Mode Only).
- Rotate the Automatic Steam Humidifier Control knob counterclockwise to the "Off" position, and observe whether the humidifier turns off ('Steam' indicator light on the humidifier should go off). If the humidifier still operates in the "Off" position, check summary wiring diagram for correct Automatic Steam Humidifier Control installation.
- If humidifier still does not shut off, refer to the troubleshooting section in the Aprilaire Steam Humidifier Installation, Operation, and Maintenance Manual.

Humidifier or Automatic Steam Humidifier Control "chatters" or clicks ON and OFF rapidly

- Check voltage at Automatic Steam Humidifier Control "24V" and "C" terminals. Voltage should be 22 VDC minimum – 26 VDC maximum.
- Make sure Outdoor Temperature Sensor wiring is not run alongside wires carrying high voltage (120 VAC or higher). (Automatic Only)

Red Diagnostic Light is on

- Check that the wiring is correct. See **Figure 9**.
- Measure the resistance of the Outdoor Temperature Sensor by removing the leads from the terminal and measuring the resistance across the wires with an ohmmeter. Confirm the reading with the temperature in **Table 4**. (For Manual Operation, verify that the resistance across the leads of the Manual Mode Resistor Case is between 44,000 and 48,000 ohms).

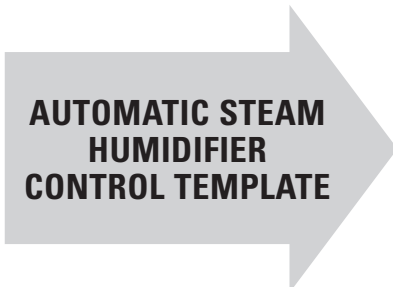

**AUTOMATIC STEAM
HUMIDIFIER
CONTROL TEMPLATE**

CUT ALONG DASHED LINE**WARNING**

Sharp edges on the opening may cause cuts. Use care when cutting the plenum opening and installing the Automatic Steam Humidifier Control.

CAUTION

- Do not mount Automatic Steam Humidifier Control on supply plenum or duct. The unit will not withstand supply temperatures and will malfunction!
- When installing Automatic Steam Humidifier Control on counterflow furnaces, ensure blower continues to run after a heat call is satisfied to eliminate high temperatures from damaging the Automatic Steam Humidifier Control.
- Do not mount Automatic Steam Humidifier Control downstream of the bypass outlet. False humidity conditions will cause humidifier to operate incorrectly.

1. CUT TEMPLATE ALONG DASHED LINE.**2. PLACE THIS TEMPLATE ON THE RETURN PLENUM UPSTREAM OF (BEFORE) THE DISPERSION TUBE.****3. TRACE THE OUTSIDE EDGES OF THIS TEMPLATE.****4. REMOVE TEMPLATE AND ACCURATELY CUT THE PLENUM OPENING.****5. USING 4 SHEET METAL SCREWS, INSTALL AUTOMATIC STEAM HUMIDIFIER CONTROL IN PLENUM OPENING.**

LIMITED WARRANTY

Your Research Products Corporation Aprilaire Automatic Steam Humidifier Control is expressly warranted for two (2) years from the date of installation to be free from defects. Research Products Corporation's exclusive obligation under this warranty shall be to supply, without charge, a replacement for any part of the Automatic Steam Humidifier Control, which is found to be defective within a two (2) year period and which is returned no later than thirty (30) days after the two (2) year period by you or your original supplier to Research Products Corporation, Madison, WI 53701, together with the model number and installation date of the Automatic Steam Humidifier Control.

THIS WARRANTY SHALL NOT OBLIGATE RESEARCH PRODUCTS CORPORATION FOR ANY LABOR COSTS AND SHALL NOT APPLY TO DEFECTS IN WORKMANSHIP OR MATERIALS FURNISHED BY YOUR INSTALLER AS CONTRASTED TO DEFECTS DISCOVERED IN THE AUTOMATIC STEAM HUMIDIFIER CONTROL ITSELF.

IMPLIED WARRANTIES OF MERCHANTABILITY OR FITNESS FOR A PARTICULAR PURPOSE SHALL BE LIMITED IN DURATION TO THE AFORESAID TWO-YEAR PERIOD. RESEARCH PRODUCTS CORPORATION'S LIABILITY FOR INCIDENTAL OR CONSEQUENTIAL DAMAGES, OTHER THAN DAMAGES FOR PERSONAL INJURIES, RESULTING FROM ANY BREACH OF THE AFORESAID IMPLIED WARRANTIES OR THE ABOVE LIMITED WARRANTY IS EXPRESSLY EXCLUDED. THIS LIMITED WARRANTY IS VOID IF DEFECT(S) RESULT FROM FAILURE TO HAVE THIS UNIT INSTALLED BY A QUALIFIED HEATING AND AIR CONDITIONING CONTRACTOR. IF THE LIMITED WARRANTY IS VOID DUE TO FAILURE TO USE A QUALIFIED CONTRACTOR, ALL DISCLAIMERS OF IMPLIED WARRANTIES SHALL BE EFFECTIVE UPON INSTALLATION.

SOME STATES DO NOT ALLOW LIMITATIONS ON HOW LONG AN IMPLIED WARRANTY LASTS OR THE EXCLUSION OR LIMITATION OF INCIDENTAL OR CONSEQUENTIAL DAMAGES SO THE ABOVE EXCLUSION OR LIMITATIONS MAY NOT APPLY TO YOU.

This warranty gives you specific legal rights and you may also have other rights, which vary, from state to state.

WARRANTY REGISTRATION

To register your Aprilaire product or for more information, visit
www.aprilairecontractor.com

If you do not have on-line access, please mail a postcard with your name, address, phone number, product purchased and date of purchase to:

Research Products Corporation
P.O. BOX 1828
Madison, WI 53701

Thank you!

Your Warranty Registration information will not be sold or shared outside of this company.

CUT ALONG DASHED LINE



1015 E. Washington Ave. • Madison, WI 53703

Phone: 888/782-8638 • Fax: 608/257-4357

www.aprilairecontractor.com

B2203636A

61000134

© 2004 Research Products Corporation